

HP 87510A
Gain-Phase Analyzer
Operation Manual

THE UNIVERSITY OF CHICAGO
 LIBRARY
 540 EAST 57TH STREET
 CHICAGO, ILL. 60637

THE UNIVERSITY OF CHICAGO
 LIBRARY

THE UNIVERSITY OF CHICAGO
 LIBRARY
 540 EAST 57TH STREET
 CHICAGO, ILL. 60637

THE UNIVERSITY OF CHICAGO
 LIBRARY
 540 EAST 57TH STREET
 CHICAGO, ILL. 60637

HP 87510A Gain Phase Analyzer

Operation Manual

MANUAL IDENTIFICATION

Model Number: HP 87510A
Date Printed: Dec 1991
Part Number: 87510-90000

This supplement contains information for correcting manual errors and for adapting the manual to newer instruments that contains improvements or modifications not documented in the existing manual.

To use this supplement

1. Make all ERRATA corrections
2. Make all appropriate serial-number-related changes listed below

SERIAL PREFIX OR NUMBER	MAKE MANUAL CHANGES
3240J00290 or later	Change 1
3427J	Change 1 and 2

◆ New Item

FIRMWARE VESION	MAKE MANUAL CHANGES
Rev 2.02 or Later	CHANGE 1
Rev 2.10 or Later	CHANGE 1 and 2

NOTE

Manual change supplement are revised as often as necessary to keep manuals as current and accurate as possible. Hewlett-Packard recommends that you periodically request the latest edition of this supplement. Free copies are available from all HP offices. When requesting copies, quote the manual identification information from your supplement, or the model number and print date from the title page of the manual.



Change 1

HP-IB Programming Manual Part

Chapter 3 HP-IB Programming Reference

The following HP-IB commands have been added to the HP 87510A with firmware revision 2.02.

LMAXS?
LMINS?
MAXD?
OUTPPEAK?
RPLPPS?
SEET
SINDTMEM
SINSPEAK
TARLRP?

SINDTMEM {ON|OFF}

SINDTMEM ON makes the analyzer store data trace to the sub-trace with each sweep. (Query)

SINSPEAK□{ON|OFF}

SINSPEAK ON makes the analyzer search the maximum or minimum point with each sweep.

OUTPPEAK?

Outputs the maximum and minimum values when SINSPEAK is set to ON. (Query)

Query response. {*minimum value*}{*stimulus value at the minimum point*}{*maximum value*}{*stimulus value at the maximum point*}{*maximum value – minimum value*}{*number of points at minimum point*}{*number of points at the maximum point*}<new line><END>

TARLRP? *value1 value2*

Searches the point at a specified target point from a point at a specified stimulus value. (Query)

value1 target value
value2 start point to search

Query response. {*stimulus value of left target point*},{*stimulus value of right target point*}<new line><END>

MAXD?

Outputs the maximum and minimum of difference between Data Trace and Sub-trace (Data Trace – Sub Trace). (Query only)

Query Response. {*Minimum value*},{*stimulus value at minimum point*},{*maximum value*},{*stimulus value at the maximum point*}<new line><END>

RPLPPS?

Searches for the maximum ripple peak to peak value and outputs the resultant data and stimulus values at these points. (Query only)

Query Response. {*maximum ripple peak*},{*stimulus value at local maximum point*},{*stimulus value at local minimum point*} <new line><END>

LMAXS? \lfloor value

Outputs the *n*th local maximum value and stimulus value from the left of range which is set by the ANARANG command. (Query only)

value 1 ~

Query response. {*n th local maximum value*},{*stimulus value at the local maximum point*} <new line><END>

3.40282347E+38 will be output when no appropriate points are found.

LMINS? \lfloor value

Outputs the *n*th local minimum value and stimulus value from the left of range which is set by the ANARANG command. (Query only)

value 1 ~

Query Response. {*n th local maximum value*},{*stimulus value at the local minimum point*} <new line><END>

3.40282347E+38 will be output when no appropriate points are found.

SEET {ON|OFF}

SEET ON makes the analyzer display both of text displayed using PRINT statement of HP Instrument BASIC and measurement traces.

Using HP Instrument BASIC with the HP 87510A Part

Page A-3, Table A-1. HP-IB Commands for EXECUTE

Add the following commands to the table A-3:

LMAXS?
LMINS?
MAXD?
OUTPPEAK?
RPLPPS?
SEET
SINDTMEM
SINSPEAK
TARLRP?



Change 2

HP-IB Programming Manual Part

Chapter 3 HP-IB Programming Reference

The following HP-IB commands have been added to the HP 87510A with firmware revision 2.10.

ATTW
UPDD

ATTW value

Sets the waiting time when the attenuator switch is changed at the power sweep mode. The waiting time is defined by *value* multiplied by 250 μ sec. (Option 010 only, No warning will be shown even if this command is executed with the HP 87510A with no option 010.) The power-on default setting is 1 ms. The preset does not have effect on this setting.

value 1 ~ 255

UPDD{ON|OFF}

Sets the refresh of the display on or off. When UPDD is turned ON, the operating speed to measure or setup will be faster. It is recommended to use this command with ALL BASIC to avoid to make a misreading because the status display on the CRT may not coincide with a current status when UPDD is turned OFF. This command is also effect to the list table. When UPDD is turned OFF, the list table does not display during editing the table. This command is not effect to the limit table.



HP 87510A Gain Phase Analyzer Operation Manual

MANUAL IDENTIFICATION

Model Number: HP 87510A
Date Printed: Dec. 1991
Part Number: 87510-90000

This supplement contains information for correcting manual errors and for adapting the manual to newer instruments that contains improvements or modifications not documented in the existing manual.

To use this supplement

1. Make all ERRATA corrections
2. Make all appropriate serial-number-related changes listed below.

SERIAL PREFIX OR NUMBER MAKE MANUAL CHANGES

SERIAL PREFIX OR NUMBER	MAKE MANUAL CHANGES

SERIAL PREFIX OR NUMBER MAKE MANUAL CHANGES

SERIAL PREFIX OR NUMBER	MAKE MANUAL CHANGES

► New Item

ERRATA

Replace the following pages with the attached replacement pages of this supplement.

Reference Manual part

- Page C-3, 4: Original to Rev:2/92
- Page C-5, 6: Original to Rev:2/92
- Page C-7, 8: Original to Rev:2/92
- Page D-1, 2: Original to Rev:2/92

HP-IB Programming Manual part

- Page 2-13, 14: Original to Rev:2/92
- Page 2-27, 28: Original to Rev:2/92
- Page 2-39, 40: Original to Rev:2/92
- Page 3-43, 44: Original to Rev:10/92
- Page 3-63, 64: Original to Rev:10/92
- Page E-17, 18: Original to Rev:2/92
- Page E-19: Original to Rev:2/92

NOTE

Manual change supplement are revised as often as necessary to keep manuals as current and accurate as possible. Hewlett-Packard recommends that you periodically request the latest edition of this supplement. Free copies are available from all HP offices. When requesting copies, quote the manual identification information from your supplement, or the model number and print date from the title page of the manual.



OUTPUT1 Output Signal or OUTPUT2 Output Signal

This signal (latch output signal) can be set at the low or high level by inputting a negative pulse to INPUT1 or using an HP-IB command. (Related HP-IB commands: OUT1H, OUT1L, OUT2H and OUT2L)

PASS/FAIL Output Signal

This signal is set to a high level (positive logic) or to a low level (negative logic) when the limit testing result is OK (PASS). It is set to a low level (positive logic) or to a high level (negative logic) when the test result is NG (FAIL). This signal is effective only when the limit test function is ON.

WRITE STROBE Output Signal for PASS/FAIL Output

When the limit testing result is output to the PASS/FAIL output line, a negative pulse is output to WRITE STROBE OUTPUT. This output signal notifies external devices of the limit testing result output to the PASS/FAIL OUTPUT.

SWEEP END Output Signal

When the HP 87510A completes a sweep, a negative pulse is output. The pulse width is 10 μ s.

A +5 V output pin is provided for an external device. A maximum of 100 mA current may be supplied. This line has no phase. However, if an excess current flows, a protective circuit functions to cut off the main power of the HP 87510A. When the overcurrent subsides, the main power is turned ON again. In this case, all device settings are initialized.

Figure C-2 shows the schematic drawing of input/output ports and control signal lines.

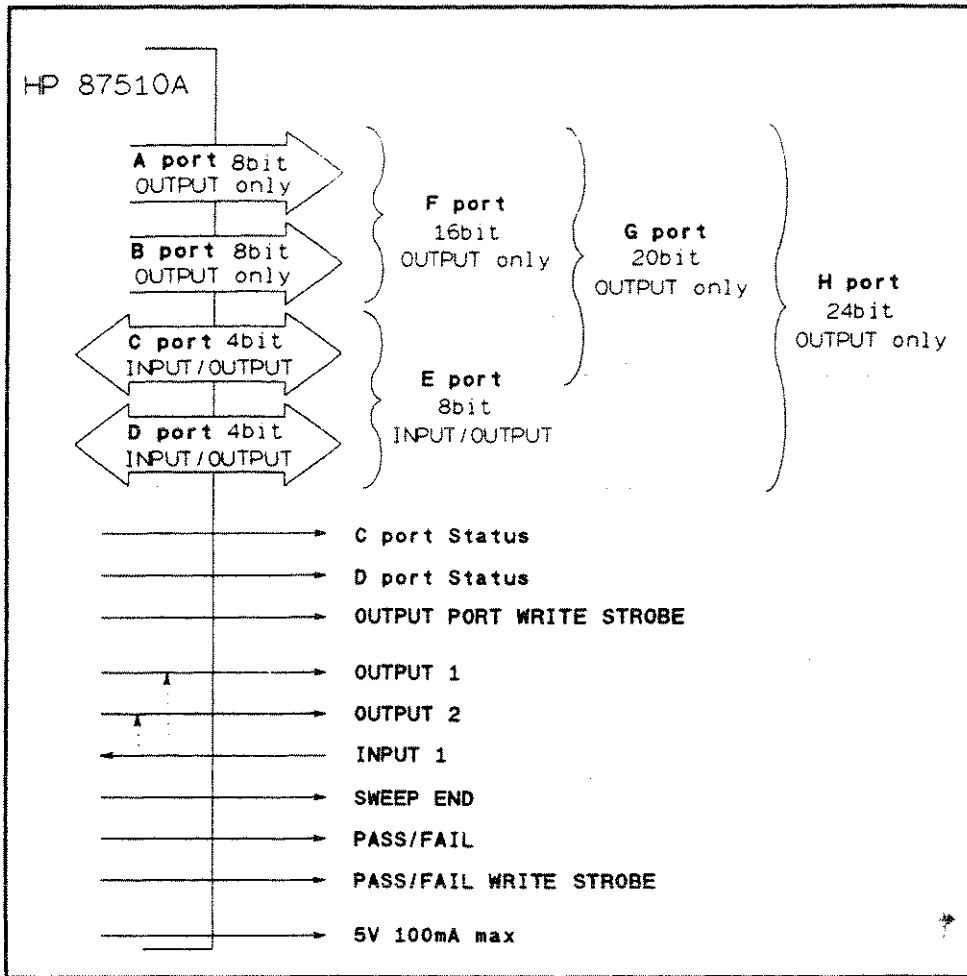

Figure C-2. Schematic Drawing of Parallel I/O Ports

Pin Assignment

Figure C-2 shows pin numbers. Table C-1 shows assignment of signals to pins.

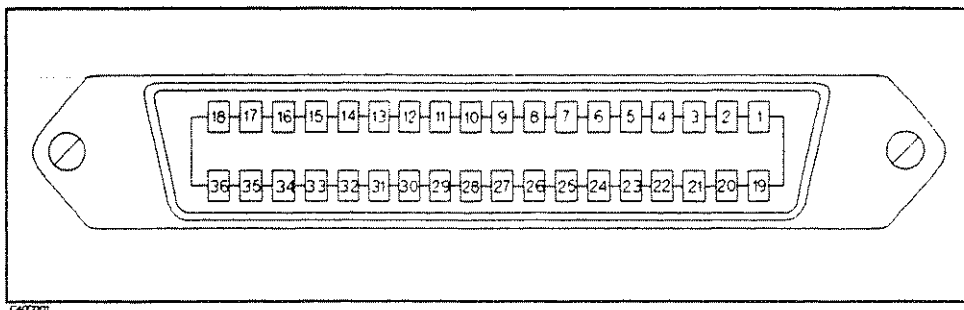

Figure C-3. Parallel I/O Port Connector Pin Numbers

Table C-1. Assignment of Signals to Pins (Standard)

Pin No.	Signal Name	Signal Standard
1	GND	0 V
2	INPUT1	TTL level, Pulse input, Pulse width of 1 μ s or more
3	OUTPUT1	TTL level, Latch output
4	OUTPUT2	TTL level, Latch output
5	Output port A0	TTL level, Latch output
6	Output port A1	TTL level, Latch output
7	Output port A2	TTL level, Latch output
8	Output port A3	TTL level, Latch output
9	Output port A4	TTL level, Latch output
10	Output port A5	TTL level, Latch output
11	Output port A6	TTL level, Latch output
12	Output port A7	TTL level, Latch output
13	Output port B0	TTL level, Latch output
14	Output port B1	TTL level, Latch output
15	Output port B2	TTL level, Latch output
16	Output port B3	TTL level, Latch output
17	Output port B4	TTL level, Latch output
18	Output port B5	TTL level, Latch output
19	Output port B6	TTL level, Latch output
20	Output port B7	TTL level, Latch output
21	Input/output port C0	TTL level, Latch output
22	Input/output port C1	TTL level, Latch output
23	Input/output port C2	TTL level, Latch output
24	Input/output port C3	TTL level, Latch output
25	Input/output port D0	TTL level, Latch output
26	Input/output port D1	TTL level, Latch output
27	Input/output port D2	TTL level, Latch output
28	Input/output port D3	TTL level, Latch output
29	Port C status	TTL level, Input mode: Low, Output mode: High
30	Port D status	TTL level, Input mode: Low, Output mode: High
31	Write strobe signal	TTL level, Negative logic, Pulse output
32	+5 V pull-up	
33	SWEEP END signal	TTL level, Negative logic, Pulse output (Width: 10 μ s or more)
34	+5 V	+5 V, 100 mA max.
35	PASS/FAIL signal	TTL level, PASS: High, FAIL: Low, Latch output
36	Write strobe signal	TTL level, Negative logic, Pulse (for PASS/FAIL) output

Table C-2. Assignment of Signals to Pins (Option 006)

Pin No.	Signal Name	Signal Standard
1	GND	0 V
2	INPUT1	TTL level, Pulse input, Pulse width of 1 μ s or more
3	OUTPUT1	TTL level, Latch output
4	OUTPUT2	TTL level, Latch output
5	Output port A0	TTL level, Latch output
6	Output port A1	TTL level, Latch output
7	Output port A2	TTL level, Latch output
8	Output port A3	TTL level, Latch output
9	Output port A4	TTL level, Latch output
10	Output port A5	TTL level, Latch output
11	Output port A6	TTL level, Latch output
12	Output port A7	TTL level, Latch output
13	Output port B0	TTL level, Latch output
14	Output port B1	TTL level, Latch output
15	Output port B2	TTL level, Latch output
16	Output port B3	TTL level, Latch output
17	Output port B4	TTL level, Latch output
18	Not used	
19	Output port B5	TTL level, Latch output
20	Output port B6	TTL level, Latch output
21	Output port B7	TTL level, Latch output
22	Input/output port C0	TTL level, Latch output
23	Input/output port C1	TTL level, Latch output
24	Input/output port C2	TTL level, Latch output
25	Input/output port C3	TTL level, Latch output
26	Input/output port D0	TTL level, Latch output
27	Input/output port D1	TTL level, Latch output
28	Input/output port D2	TTL level, Latch output
29	Input/output port D3	TTL level, Latch output
30	Port C status	TTL level, Input mode:Low, Output mode:High
31	Port D status	TTL level, Input mode:Low, Output mode:High
32	Write strobe signal	TTL level, Negative logic, Pulse output
33	SWEEP END signal	TTL level, Negative logic, Pulse output (Width: 10 μ s or more)
34	PASS/FAIL signal	TTL level, PASS:High, FAIL: Low, Latch output
35	+5 V	+5 V, 100 mA max.
36	Write strobe signal	TTL level, Negative logic, Pulse output

HP-IB Commands for Parallel I/O Port Control

The HP-IB commands related to parallel I/O ports are summarized below. For more information on HP-IB commands, *see the HP-IB Programming Manual.*

Note



The HP-IB commands summarized below are used to control the standard Parallel I/O and Option 006. For the HP-IB commands related to Option 005 (8-bit I/O), *see Appendix D.*

Data Output Commands

The following commands output data to the corresponding ports (A to H). When ports C, D, E, F, G, and H are used as output ports, ports C and D must be defined as output ports using HP-IB commands (COUT and DOUT).

- OUTAIO outputs 8-bit data to port A.
- OUTBIO outputs 8-bit data to port B.
- OUTCIO outputs 4-bit data to port C.
- OUTDIO outputs 4-bit data to port D.
- OUTEIO outputs 8-bit data to port E.
- OUTFIO outputs 16-bit data to port F.
- OUTGIO outputs 20-bit data to port G.
- OUTHIO outputs 24-bit data to port H.

Data Input Commands

The following commands read data from the corresponding input ports (C to E) and returns the values to the HP-IB. Before receiving data, ports C and D must be defined as input ports using HP-IB commands (CIN and DIN).

- OUTPINPCIO? reads 4-bit data from port C and returns its value to the HP-IB.
- OUTPINPDIO? reads 4-bit data from port D and returns its value to the HP-IB.
- OUTPINPEIO? reads 8-bit data from port E and returns its value to the HP-IB.

Commands for Setting Input/Output Directions of Ports C and D

The following commands set the input/output directions of ports C and D. When the power is turned ON, ports C and D are defined as input ports. Pressing **PRESET** key do not affect this setting. This setting is saved to an instrument state file using the Save function.

- CIN defines port C as an input port.
- COUT defines port C as an output port.
- DIN defines port D as an input port.
- DOUT defines port D as an output port.

Positive and Negative Logic Setting Commands

The following commands set positive or negative logic for port input/output signals and PASS/FAIL output signal. When the power is turned ON, negative logic is set. Pressing **PRESET** key do not affect this setting. This setting is saved to an instrument state file using the Save function.

- NEGL sets negative logic.
- POSL sets positive logic.

OUTPUT1 and OUTPUT2 Level Setting Commands

The following commands set OUTPUT1 and OUTPUT2 levels:

- OUT1H sets OUTPUT1 at the high level.
- OUT1L sets OUTPUT1 at the low level.
- OUT2H sets OUTPUT2 at the high level.
- OUT2L sets OUTPUT2 at the low level.

Commands for Setting OUTPUT1 and OUTPUT2 at the High or Low Level upon input of a Pulse to INPUT1

The following commands set OUTPUT1 and OUTPUT2 at the high or low when a negative pulse is input to INPUT1. When the power is turned ON, both OUTPUT1 and OUTPUT2 are set at the high level. Pressing **(PRESET)** key do not affect this setting. This setting is saved to an instrument state file using the Save function.

- OUT1ENVH sets OUTPUT1 at the high level when a pulse is input to INPUT1.
- OUT1ENVL sets OUTPUT1 at the low level when a pulse is input to INPUT1.
- OUT2ENVH sets OUTPUT2 at the high level when a pulse is input to INPUT1.
- OUT2ENVL sets OUTPUT2 at the low level when a pulse is input to INPUT1.

Command for Checking Input to INPUT1

This command checks whether a pulse has been input to INPUT1. Sending this command after a pulse is input to INPUT1 will return a HIGH. If no pulse has been input to INPUT1, the return values will be LOW. After HIGH is received, succeeding values will be cleared. (set to LOW)

Option 005 Parallel I/O Mode A (8-bit)

This appendix provides information on the HP 87510A with Option 005 Parallel I/O Mode A (8-bit I/O port).

I/O Port

The I/O port on the analyzer rear panel communicates with the external devices such as a handler on a production line.

Pin Assignment

The 8-bit I/O port consists of 15 TTL compatible signals, which are 8-bit output, 4-bit input, sweep end, pass/fail, and ground. The pin assignments are shown in Figure D-1.

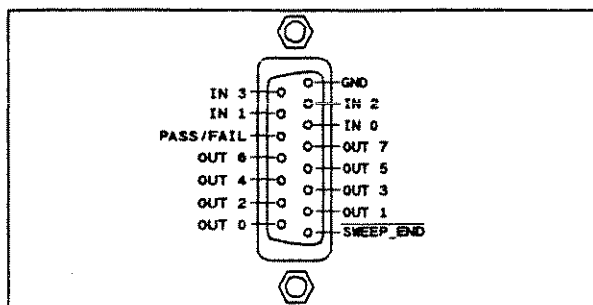

Figure D-1. 8-bit I/O Port Pin Assignments

The signals carried through each pin are described below.

<u>SWEEP_END</u>	outputs a negative pulse when the analyzer completes a sweep. The pulse width is $> 10 \mu\text{s}$.
OUT 0 thru 7	output signals to external devices and are controlled by two HP-IB commands, OUT8IO, as described below. Once OUT8IO is executed, the signal is latched until OUT8IO is executed again.
IN 0 thru 4	input signals from external devices and are read by the HP-IB command INP8IO, as described below.
PASS/FAIL	is affected only when the Limit Testing, described in "Limit Line and Limit Testing" in Chapter 12, is active. This signal is set HIGH and LOW if the test result is PASS and FAIL (positive logic), or FAIL and PASS (negative logic) respectively.

Related HP-IB Commands

There are six HP-IB commands which directly control an I/O port.

- OUT8IO** outputs 8-bit data to the OUT 0 thru 7 lines. The OUT 0 signal is the LSB (least significant bit), while the OUT 7 signal is the MSB (most significant bit).
- INP8IO** inputs 4-bit data from the IN 0 thru 3 signals to the analyzer's memory. The IN 0 signal is the LSB (least significant bit), while the IN 3 signal is the MSB (most significant bit).
- INP8IO?** inputs data from the 4-bit parallel input port to the HP 87510A, and outputs the data to the controller.
- NEGL** sets negative logic for the PASS/FAIL output signal. When the power is turned ON, negative logic is set. Pressing **PRESET** key do not affect this setting. This setting is saved to an instrument state file using the Save function.
- OUTPINP8IO?** is a query command which outputs 8-bit data to the controller. The data is obtained as 4-bit data by the INP8IO command and four upper significant bits (value = 0) are attached to extend the 4-bit data to 8-bit data.
- POSL** sets positive logic for the PASS/FAIL output signal. When the power is turned ON, negative logic is set. Pressing **PRESET** key do not affect this setting. This setting is saved to an instrument state file using the Save function.

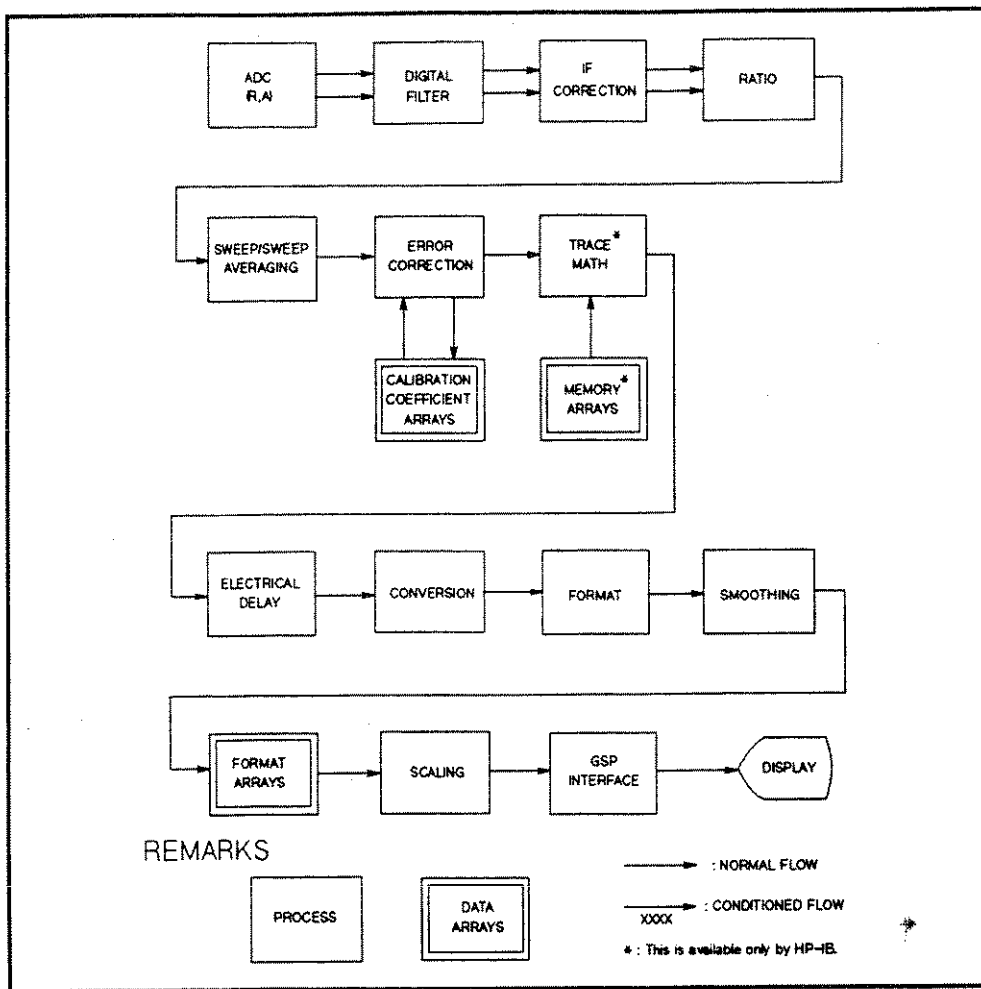

Figure 2-8. Data Processing Flow

Table 2-2. HP-IB Commands to Output Data Array

Data Output	Active Channel		Inactive Channel	
	Formatted Data		Formatted Data	
	Data Trace	Sub Trace	Data Trace	Sub Trace
Complex Data at All Points ¹	OUTPFORM?	OUTPTMEM?	OUTPPIFORM?	OUTPITMEM?
Complex Data at Specified Point ²	OUTPFORMP?	OUTPTMEMP?		
Real Data at All Point ³	OUTPRFORM?	OUTPRTMEM?	OUTPIRFORM?	OUTPIRTMEM?

1 Number of data output is two times of the Number Of Points (NOP).

2 Number of data output is two (a real part and an imaginary part).

3 Number of data output is equal to NOP.

Data Transfer Using ASCII Transfer Format (Form 4). When Form 4 is used, each number is sent as a 24 character string, each character being a digit, or decimal point.

```

10      !
20      ! Data Transfer Using ASCII Transfer Format
30      !
40      DIM Dat(1:201),Stim(1:201)
50      ASSIGN @Hp87510 TO 717 ! When iBASIC is used, change "717" to "800".
60      ABORT 7                ! When iBASIC is used, change "7" to "8".
70      CLEAR @Hp87510
80      !
90      OUTPUT @Hp87510;"PRES"           ! Preset HP 87510A
100     OUTPUT @Hp87510;"CHAN1; AR; LOGM"
110     INPUT "Enter center frequency (Hz).",F_cent
120     INPUT "Enter frequency span (Hz).",F_span
130     OUTPUT @Hp87510;"CENT ";F_cent
140     OUTPUT @Hp87510;"SPAN ";F_span
150     !
160     ON INTR 7 GOTO Sweep_end          ! Define branch when interrupt occurs
170     OUTPUT @Hp87510;"CLES"           ! Clear status registers
180     OUTPUT @Hp87510;"*SRE 4;ESNB 1" ! Set enable bits of STB and ESB
190     REPEAT                            ! Wait for registers are cleared
200     UNTIL SPOLL(@Hp87510)=0          ! Check STB
210     ENABLE INTR 7;2                  ! Set enable interrupt
220     OUTPUT @Hp87510;"SING"           ! Sweep mode is SINGLE
230     Loop_top:GOTO Loop_top           ! Wait until sweep end
240     Sweep_end:                        !
250     !
260     OUTPUT @Hp87510;"POIN?"          ! Query NOP
270     ENTER @Hp87510;Nop
280     OUTPUT @Hp87510;"FORM4"         ! Set ASCII Transfer Format
290     !
300     OUTPUT @Hp87510;"OUTPRFORM?"    ! Real part of the formatted trace data
310     ENTER @Hp87510;Dat(*)
320     !
330     OUTPUT @Hp87510;"OUTPSTIM?"     ! Stimulus data
340     ENTER @Hp87510;Stim(*)
350     !
360     FOR I=1 TO Nop
370         PRINT Stim(I);"Hz",Dat(I);"dB"
380     NEXT I
390     END

```

Figure 2-9. Sample Program: Data Transfer using ASCII Transfer Format (Form 4)

Lines 260 and 270	Find out how many points to expect.
Line 280	Tell the HP 87510A to use the ASCII transfer format.
Line 300	Request the real part of the formatted trace data.
Line 310	Transfer the data from the HP 87510A to the computer, and put it in the receiving array Dat(*).
Lines 330 and 340	Request and transfer the stimulus data.
Lines 340 through 380	Display data.

```

10      !
20      ! Reading Calibration Data
30      !
40      DIM Dat(1:201,1:2)
50      DIM Head$(6)
60      ASSIGN @Hp87510 TO 717 ! When iBASIC is used, replace "717" to "800".
70      ABORT 7 ! When iBASIC is used, replace "7" to "8".
80      CLEAR @Hp87510
90      !
100     INPUT "Connect THRU and press [Return] to do cal.",Dum$
110     GOSUB Setup
120     GOSUB Cal
130     OUTPUT @Hp87510;"SAVC" ! Re-draw trace
140     OUTPUT @Hp87510;"POIN?" ! Ask Number of points
150     ENTER @Hp87510;Nop ! Enter NOP
170     !
180     INPUT "Press [Return] to transmit cal data.",Dum$
190     ASSIGN @Dt TO 717;FORMAT OFF ! Set data I/O path
200     OUTPUT @Hp87510;"FORM3" ! IEEE 64-bit Floating Point Format
210     OUTPUT @Hp87510;"OUTPCALC01?" ! Query calibration array
220     ENTER @Dt USING "#,8A";A$ ! Enter header
230     ENTER @Dt;Dat(*) ! Enter data
240     ENTER @Dt USING "#,1A";B$ ! Enter terminator
250     INPUT "Transmit done. Disconnect THRU and press [Return].",Dum$
260     !
270     GOSUB Setup
280     GOSUB Cal
290     OUTPUT @Hp87510;"SAVC" ! Re-draw trace
300     !
310     INPUT "Press [Return] to retransmit cal data.",Dum$
320     V$=VAL$(Nop*2*8)
330     Numv=LEN(V$)
340     Head$="000000" ! Initialize header value
350     FOR I=1 TO Numv
360         Head$[7-I,7-I]=V$[Numv-I+1,Numv-I+1]
370     NEXT I
380     !
390     OUTPUT @Hp87510;"INPUCALC01 "; ! Store cal data by HP-IB
400     OUTPUT @Dt USING "#,8A";"#6"&Head$ ! Send header
410     OUTPUT @Dt;Dat(*),END ! Send data
420     OUTPUT @Hp87510;"SAVC" ! Re-draw trace
430     !
440     ASSIGN @Dt TO * ! Clear I/O path
460     DISP "Retransmit completed. Connect DUT."
470     OUTPUT @Hp87510;"CONT" ! Sweep mode is CONT
480     STOP
490     !

```

Figure 2-15. Reading Calibration Data (1/2)

```

500 Setup: !
510 F_cent=7.E+7
520 F_span=200000.
530 OUTPUT @Hp87510;"PRES;"
540 OUTPUT @Hp87510;"CHAN1; AR; LOGM"
550 OUTPUT @Hp87510;"CENT ";F_cent
560 OUTPUT @Hp87510;"SPAN ";F_span
570 OUTPUT @Hp87510;"SING"
580 RETURN
590 !
600 Cal: !
610 OUTPUT @Hp87510;"swet 4"
620 OUTPUT @Hp87510;"CALIRESP"
630 ON INTR 7 GOTO Sweep_end
640 OUTPUT @Hp87510;"CLES"
650 OUTPUT @Hp87510;"*SRE 4;ESNB 1"
660 REPEAT
670 UNTIL SPOLL(@Hp87510)=0
680 ENABLE INTR 7;2
690 OUTPUT @Hp87510;"STANC"
700 Loop_top:GOTO Loop_top
710 Sweep_end: !
720 !
730 OUTPUT @Hp87510;"*OPC?"
740 ENTER @Hp87510;Dum
750 OUTPUT @Hp87510;"RESPDONE"
760 RETURN
770 END

```

Figure 2-15. Reading Calibration Data (2/2)

Line 50	Declare the dimension part of the file header.
Line 110	Preset and set up the HP 87510A, and hold the trigger.
Line 120	Perform a response calibration.
Line 130	Re-draw the trace with the calibration data.
Line 210	Request outputting the calibration data.
Line 220	Enter the file header.
Line 230	Enter the calibration data.
Line 240	Enter the file terminator.
Line 280	Perform the calibration to set the correction ON.
Line 320	Calculate the number of bytes transferred, and represents it in the string format.
Line 330	Count the number of characters in the string which contains the number of bytes transferred.
Line 340	Enter 0 as the initial value in all header arrays.
Line 350 through 370	Place the number of bytes transferred to the header array digit by digit from the sixth array to the first array of the header.
Line 390 through 410	Send the file header and calibration data.

OFSD value [s]

Specifies the one-way electrical delay from the measurement (reference) plane to the standard.

(**OFFSET DELAY** under **CAL**)

value -10 to 10 (s)

OFSL value

Specifies energy loss, due to skin effect, along a one-way length of coaxial cable offset.

(**OFFSET LOSS** under **CAL**)

value 0 to 1.0×10^{19} (Ω/s)

OFSZ value [ohm]

Specifies the characteristic impedance of the coaxial cable offset.

(**OFFSET Z0** under **CAL**)

value 0.1 to 5.0×10^6 (Ω)

OPEP

Lists the key parameters for both channels 1 and 2 on the display.

(**OPERATING PARAMETERS** under **COPY**)

OPTI?

Returns installed option number of the front panel ports. If nothing is installed, OPTI? returns the string, "STD". If Option 004 (delete reference channel option) is installed, OPTI? returns "004". (query only)

OSE value

Enables the operational status register.

value 0 to 32,767

OSER?

Outputs the current value in the event register of an operational status register.

OSNT

Sets the negative transition filter of an operational status register. For details, refer to Appendix B. (Query)

OSPT

Sets the positive transition filter of an operational status register. For details, refer to Appendix B. (Query)

OSR?

Outputs the operational status register value.

OUT1ENVH

Sets OUTPUT1 set to HIGH when a pulse input has occurred at INPUT1.

OUT1ENVL

Sets OUTPUT1 set to LOW when a pulse input has occurred at INPUT1.

OUT1H

Sets OUTPUT1 to HIGH.

OUT1L

Sets OUTPUT1 to LOW.

OUT2ENVH

Sets OUTPUT2 set to HIGH when a pulse input has occurred at INPUT1.

OUT2ENVL

Sets OUTPUT2 set to LOW when a pulse input has occurred at INPUT1.

OUT2H

Sets OUTPUT2 to HIGH.

OUT2L

Sets OUTPUT2 to LOW.

OUT8IO *value*

Outputs the data to the 8-bit parallel output port. (Option 005 only)

value 0 to 255

OUTPFILT? *value*[*suffix*]

Outputs filter parameters within the range specified by the ANARANG command. Command parameter sets the offset of x dB to the maximum peak value to determine the cutoff points. For details, refer to Appendix E. (Data format: loss, bandwidth, center frequency, Q, $\Delta L.F$, $\Delta R.F$)

value Relative offset value from maximum
suffix refer to "Suffix"

OUTPFORM?

Outputs the formatted trace data (Data format: real, imaginary)

OUTPFORMP? *value*

Outputs the formatted trace data at the specified point (Data format: real, imaginary)

value 1 to "number of points"

OUTPIFORM?

Outputs the formatted data from the inactive channel (Data format: real, imaginary)

OUTPINP8IO?

Outputs the data entered from the 4-bit parallel input port. (option 005 only)

OUTPINPCIO?

Outputs the data entered from port C (4 bit) of the 24-bit I/O port.

OUTPINPDIO?

Outputs the data entered from port D (4 bit) of the 24-bit I/O port.

OUTPINPEIO?

Outputs the data entered from port E (8 bit) of the 24-bit I/O port.

OUTPIRFORM?

Outputs the real part of the formatted data from the inactive channel.

OUTPIRTMEM?

Outputs the real part of the trace memory data from the inactive channel.

OUTPITMEM?

Outputs the trace memory data from the inactive channel. (Data format: real, imaginary)

OUTPLIMF?

Outputs the limit test results only for the failed points. (Data format: stimulus, result (always 1), upper limit, lower limit; Form 4)

OUTPLIML?

Outputs the limit test results for each point. (Data format: stimulus, result (0 for pass, 1 for fail, -1 for no test), upper limit, lower limit; Form 4)

OUTPLIMM?

Outputs the limit test result for the marker position. (Data format: stimulus, result (0 for pass, 1 for fail, -1 for no test), upper limit, lower limit)

OUTPMARK?

Outputs the active marker values. (Data format: marker value, marker aux. value, stimulus)

OUTPMAX?

Outputs the maximum value within the range specified with the ANARANG command. For details, refer to Appendix E. (Data format: maximum, stimulus)

OUTPMEAN?

Outputs the mean value within the range specified with the ANARANG command. For details, refer to Appendix E. (Data format: mean)

OUTPMEMO?

Outputs the memory data from the active channel. (Data format: real, imaginary)

OUTPMEMOT?

Outputs memory trace value on 16 points stimulus which is set by the STIMROUT command. If there are points that is not set by STIMROUT command, OUTPMEMOT? returns the value at 100 kHz. (Data format: real × 16)

OUTPMEMTP? *value*

Outputs the memory data at a specified point. (Data format: real, imaginary)

value 1 to "number of points"

STDTARBI

Defines the standard type to LOAD with an arbitrary impedance.

(ARBITRARY IMPEDANCE under CAL); Query)

STDTDELA

Defines the standard type as transmission line of specified length.

(DELAY/THRU under CAL); Query)

STDTLOAD

Defines the standard type as LOAD (termination).

(LOAD under CAL); Query)

STDTOPEN

Defines the standard type as an OPEN.

(OPEN under CAL); Query)

STDTSHOR

Defines the standard type as a SHORT.

(SHORT under CAL); Query)

STIDROUT{1-16} *value* [*suffix*]

Sets stimulus of data trace up to 16 for OUTPDATAT? query. To execute STIDROUT? query, pass a number as the parameter.

value 1 (kHz) to 300 (MHz)
suffix refer to "Suffix"

STIMROUT{1-16} *value* [*suffix*]

Sets stimulus of memory trace up to 16 for OUTPDATAT? query. To execute STIDROUT? query, pass a number as the parameter.

value 1 (kHz) to 300 (MHz)
suffix refer to "Suffix"

STODDISK

Selects internal flexible disk drive for mass storage device.

STODMEMO

Selects RAM disk drive for mass storage device.

STOP *value* [*suffix*]

Defines the stop value of the stimulus. ((STOP); Query)

Sets the stop frequency of a segment.

(STOP under MENU; Query)

value 1 (kHz) to 300 (MHz)

suffix refer to "Suffix"

STPSIZE *value* [*suffix*]

Specifies the frequency step for a list sweep table.

(STEP SIZE under MENU; Query)

value 0 to 299.999 (MHz)

suffix refer to "Suffix"

SWET *value* [s]

Manually sets the sweep time.

(SWEEP TIME under MENU; Query)

value 6.0×10^{-4} to 86,400 (s)

SWETAUTO

Automatically sets the sweep time.

(SWEEP TIME AUTO under MENU; Query)

SWPT *parameter*

Selects the sweep type. (Query)

<i>parameter</i>	<i>description</i>
LINF	Linear frequency
LOGF	Log frequency
LIST	Frequency list

TARL? *value*

Outputs stimulus of first found point which has value specified by parameter of this command from right of range which is set by ANARANG command. For more information, refer to Appendix E. (Data format: stimulus)

value 1 (kHz) to 300 (MHz)

suffix refer to "Suffix"

OUTPRESF?

OUTPRESF? searches maximum local-maximum (fs) and minimum local-minimum (fp) within specified range, then, searches x1 dB below points for both side from fs and x2 dB above points for both side from fp. The first point founded on the left-hand side of fs is fs1, and right-hand side is fs2. In a similar way, fp1 is first point found on the left-hand side of fp, and fp2 is right-hand point. See Figure E-19.

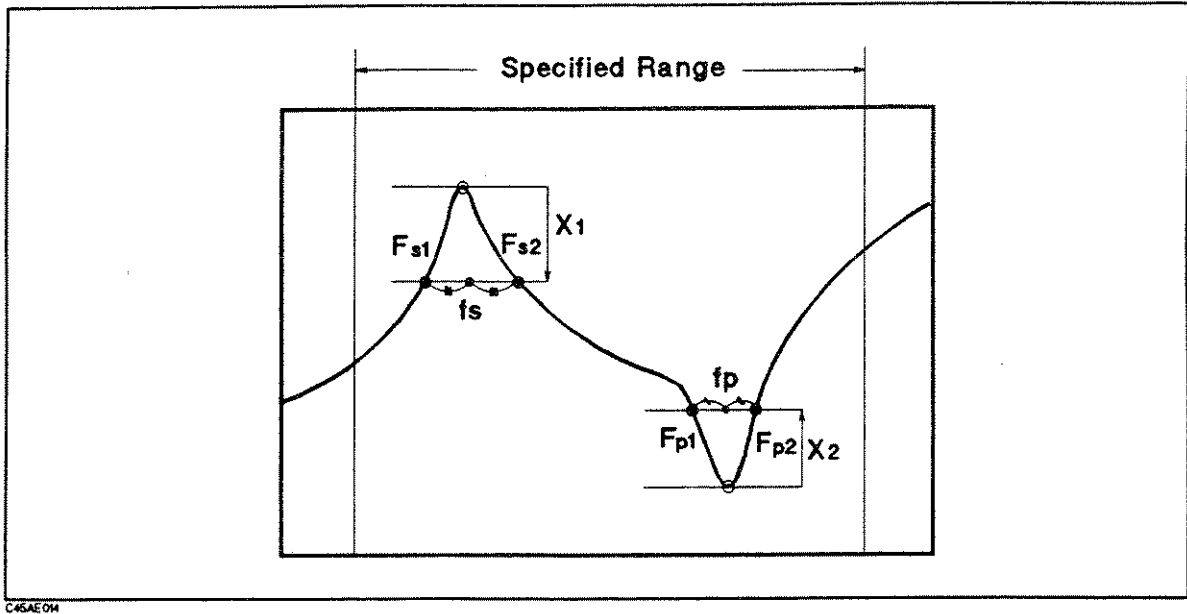

Figure E-19. OUTPRESF?

Equivalent Circuit Analysis Commands

The following commands make an equivalent circuit analysis for the measurement data and return the analysis result. The equivalent circuit analysis is made within the range specified by the ANARANG command. Following commands are only available when the polar format and admittance conversion is selected.

EQUCPARA?

The EQUCPARA? command makes a 4-device equivalent circuit analysis for the crystal resonator and returns equivalent circuit constants. The EQUCPARA? regards the following circuits as equivalent circuits:

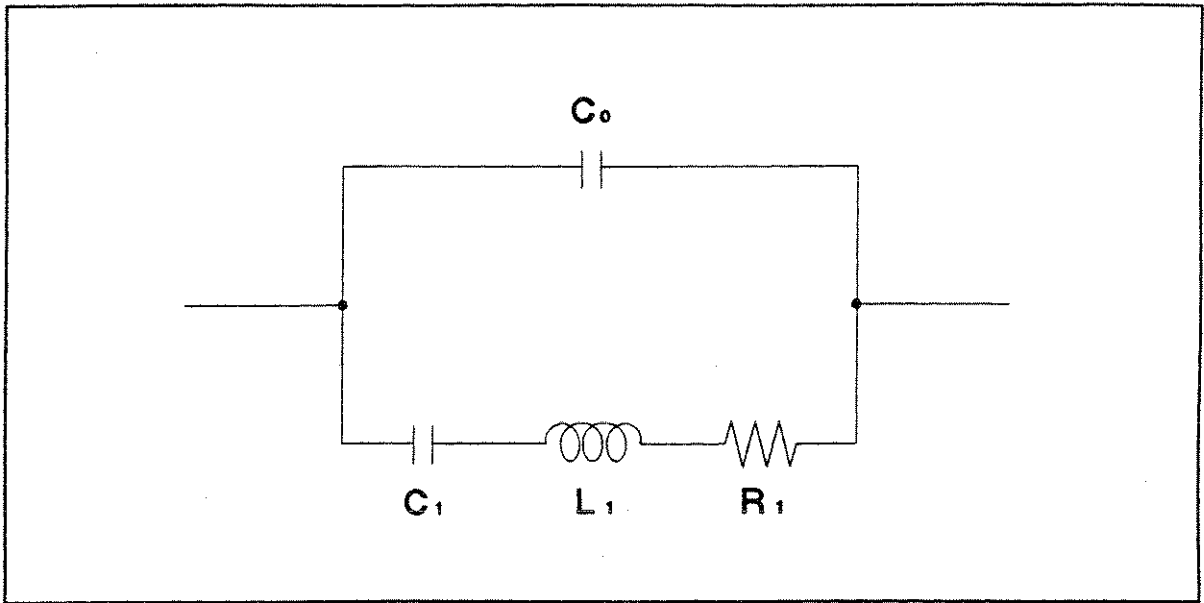

Figure E-20. Four-Device Equivalent Circuit for Crystal Resonator

Where,

- C_0 : Parallel capacity
- C_1 : Motional capacity
- L_1 : Motional inductance
- R_1 : Motional resistance

The EQUCPARA? command obtains the above constants in the following procedure:

1. Obtains the admittance characteristic circle diagram.
2. Obtains the susceptance (Bfs) and its frequency (fs) at the maximum conductance (Gmax) point.
3. Obtains frequencies f_1 and f_2 ($f_1 < f_2$) of two points where the conductance is half the maximum conductance (Gmax).
4. Assumes that the frequency at which the phase becomes 0° near the parallel resonance frequency is f_a .
5. Assumes that the frequency at which the phase becomes 0° near the series resonance frequency is f_r .
6. Calculates the constants using the above values and the following equations:

$$R_1 = \frac{1}{G_{max}}$$

$$L_1 = \left| \frac{Q \times R_1}{2\pi f_s} \right|$$

$$C_1 = \frac{1}{QR_1 \times 2\pi f_s}$$

$$C_0 = \left(\frac{f_r^2}{f_a^2 - f_r^2} \right)$$

Where,

$$Q = \left| \frac{f_s}{f_2 - f_1} \right|$$

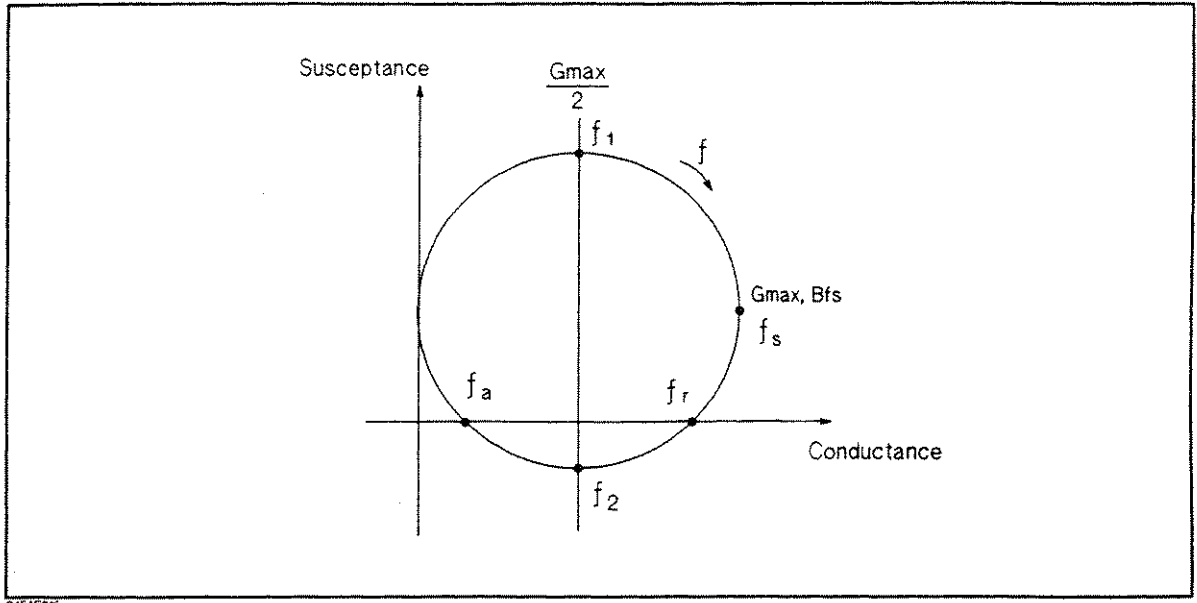

Figure E-21. Admittance Characteristic Chart

If there are no f_r and f_a points on the admittance chart, C_0 is calculated using the following equation:

$$C_0 = \frac{Bfs}{2\pi f_s}$$

EQUCPARS?

The EQUCPARS? command returns f_s , f_a , f_r , f_1 , and f_2 in addition to C_0 , C_1 , L_1 , and R_1 which are returned by the EQCUPARA? command. For more information on parameters, see "EQCUPARA?".



*

**HP 87510A
Gain-Phase Analyzer
Operation Manual**

MANUAL IDENTIFICATION

Model Number: HP 87510A
Date Printed: Dec. 1991
Part Number: 87510-90000

This supplement contains information for correcting manual errors and for adapting the manual to newer instruments that contains improvements or modifications not documented in the existing manual.

- To use this supplement
1. Make all ERRATA corrections
 2. Make all appropriate serial-number-related changes listed below

SERIAL PREFIX OR NUMBER MAKE MANUAL CHANGES

SERIAL PREFIX OR NUMBER MAKE MANUAL CHANGES

► New Item

ERRATA

Using HP Instrument BASIC part

Page 7-7, Using the 8-bit I/O Port in BASIC Programs (option 005 only)

Change the description as follows:

READIO(15,2) reads the 4-bit data from the 8-bit I/O port and returns it as a decimal value.

Page A-5, READIO

Change the table item as following:

Item	Description	Range
register number	numeric expression	0 to 800 (Select code 8) 2 to 4 (Select code 15) 2 (Select code 15: option 005 only)

NOTE

Manual change supplement are revised as often as necessary to keep manuals as current and accurate as possible. Hewlett-Packard recommends that you periodically request the latest edition of this supplement. Free copies are available from all HP offices. When requesting copies, quote the manual identification information from your supplement, or the model number and print date from the title page of the manual.



MANUAL CHANGES

HP 87510A Gain-Phase Analyzer Operation Manual

MANUAL IDENTIFICATION

Model Number: HP 87510A Date Printed: Dec. 1991 Part Number: 87510-90000
--

This supplement contains information for correcting manual errors and for adapting the manual to newer instruments that contains improvements or modifications not documented in the existing manual.

To use this supplement

1. Make all ERRATA corrections
2. Make all appropriate serial-number-related changes listed below

SERIAL PREFIX OR NUMBER	MAKE MANUAL CHANGES
All	Chapter 1
3240J	Chapter 2-4

SERIAL PREFIX OR NUMBER	MAKE MANUAL CHANGES

► New Item

This manual change sheet includes following contents:

Errata for the *Operation Manual* Chapter 1
Supplemental information for the revision 2.0 or later Chapter 2 to 4

NOTE

Manual change supplement are revised as often as necessary to keep manuals as current and accurate as possible. Hewlett-Packard recommends that you periodically request the latest edition of this supplement. Free copies are available from all HP offices. When requesting copies, quote the manual identification information from your supplement, or the model number and print date from the title page of the manual.



Errata for Operation Manual

This chapter provides errata correction information of for the *Operation Manual*.

Function Reference Part

Page 2-4, Option Available

Change Item	To
Option 0B0, Delete Operation Manual	Option 009, Delete Operation Manual
Option 0B1, Extra Operation Manual	Option 910, Extra Operation Manual

Page C-8, Command for Checking Input to INPUT1

Change the description as follows:

INPT? command checks whether a pulse has been input to the INPUT1. Sending INPU? after a pulse is input to the INPUT1 will return 1. If no pulse has been input to the INPUT1, the return value will be 0. Once 1 is read, this value will be cleared. (Set to 0.)

HP-IB Programming Manual Part

Change as follows:

Page 3-46, OUTPTESS? value

Outputs the specified test number's result. For more information, refer to the *Service Manual*. (Under SERVICE MENU under **SYSTEM**)

value 0 to 54

Page 3-65, TARL? value

Output stimulus of the first found point which has a value specified by the parameter of this command for left direction from the right edge of analysis range which is set by the ANARANGE command. For more information, see Appendix E. (Data format: stimulus)

value -5.0×10^5 to 5.0×10^5 (dB) (Log mag format)
 -5.0×10^5 to 5.0×10^5 (deg) (Phase and Expanded phase formats)
 -5.0×10^5 to 5.0×10^5 (s) (Delay format)
 -5.0×10^5 to 5.0×10^5 (Units) (Polar, Lin mag, Real, and Imaginary formats)

suffix refer to "Suffix"

Page 3-65, TARR value

Output stimulus of the first found point which has value specified by parameter of this command for right direction from the left edge of analysis range which is set by ANARANGE command. For more information, see Appendix E. (Data format: stimulus)

value -5.0×10^5 to 5.0×10^5 (dB) (Log mag format)
 -5.0×10^5 to 5.0×10^5 (deg) (Phase and Expanded phase formats)
 -5.0×10^5 to 5.0×10^5 (s) (Delay format)
 -5.0×10^5 to 5.0×10^5 (Units) (Polar, Lin mag, Real, and Imaginary formats)

suffix refer to "Suffix"

Page 3-67, *TST?

Executes a power-on self test and returns the test result.

Page E-13, OUTPXFL?

Change Figure E-14 to the following figure:

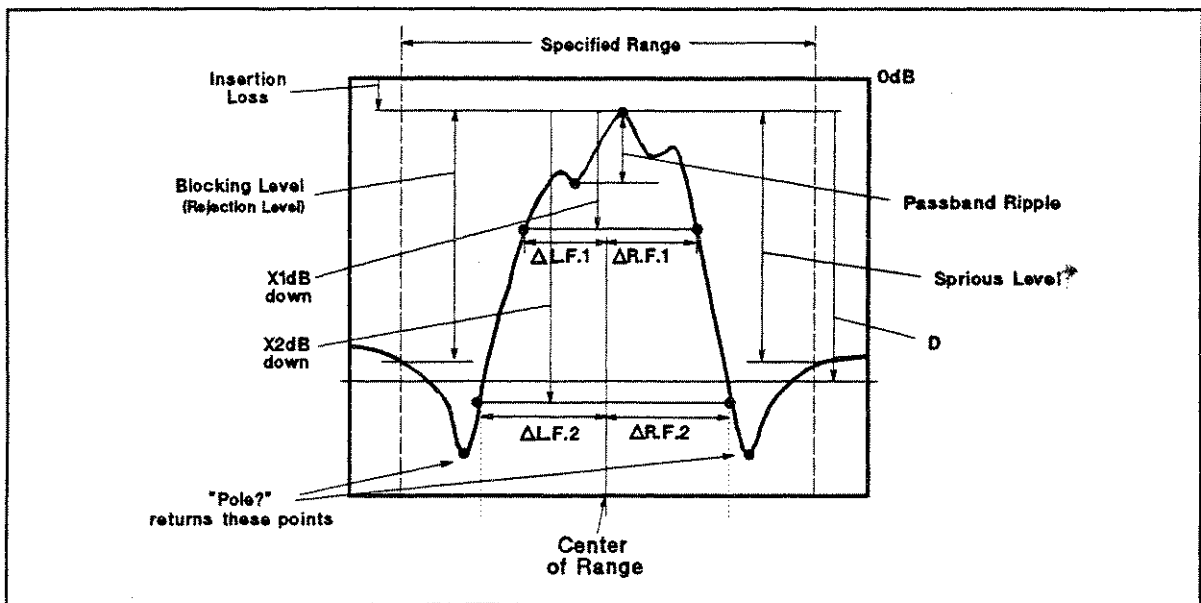

Figure E-14. OUTPXFL?

Page E-14, OUTPCFIL?

Change Figure E-15 to the following figure:

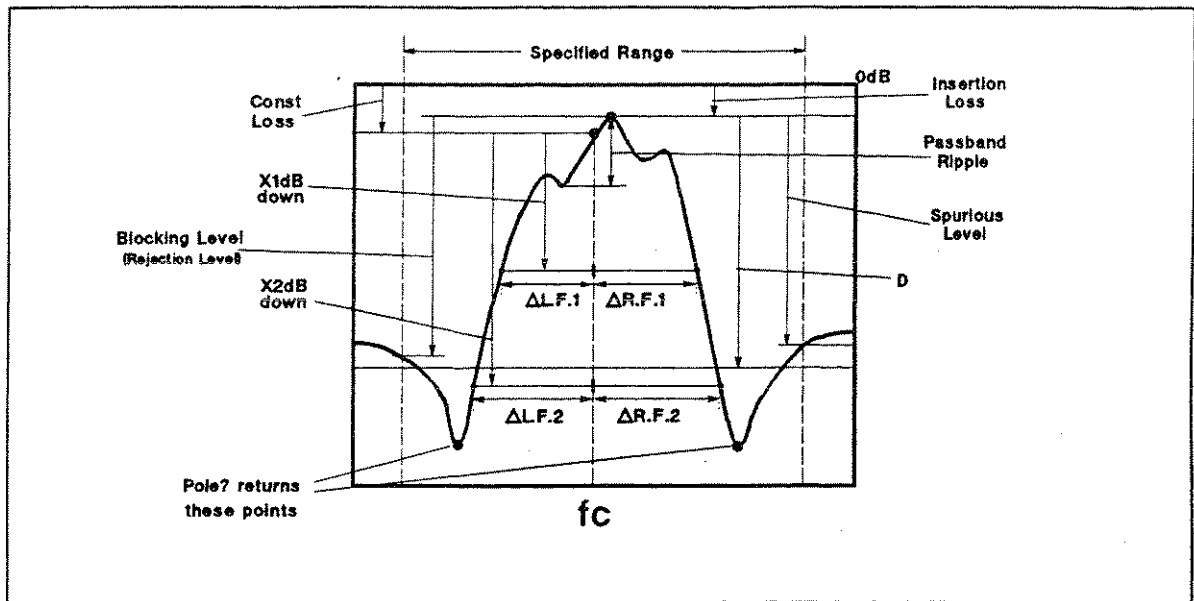

Figure E-15. OUTPCFIL?

Page G-2, One-Point Correction

Add a following line to the sample program:

```
185 OUTPUT @Hp87510;"RECCOFF" Turn OFF the receiver correction.
```

Note



The notation, *svc*, is displayed on the left of the grid. This is not an obstacle to the operation. To turn off this notation, execute the following line:

```
OUTPUT @Hp87510;"RECCON" Turn ON the receiver correction.
```

Using HP Instrument BASIC part

Change Figure 10-14 to the following figure:

```
10 INPUT "ENTER FILE NAME (without EXT.)",File_name$
20 MASS STORAGE IS ":INTERNAL" ! Select flexible disk drive
21                               ! When you want to use RAM disk,
22                               ! change ":INTERNAL" to ":MEMORY"
30 DIM Dat(1:201,1:2)           ! Assume data size of "Dat" is 201 points
40 File_name$=File_name$&"_D" ! Add extension "_D" to filename
41                               ! When you want to use DOS format,
42                               ! change extension "_D" to ".DAT"
50 ASSIGN @File TO File_name$ ! Open target file
60 ENTER @File USING "17X,#" ! Skip the data header
70 INTEGER Nop                 ! Declare the variable, "Nop"
80 ENTER @File;Nop             ! Skip a NOP data of header
90 ENTER @File USING "4X,#" ! Skip the header
100 ENTER @File;Dat(*)         ! Load data from file
110 ASSIGN @File TO *         ! Close file
120 PRINT Dat(*)              ! Print data
130 END
```

Figure 10-14. Loading Trace Data

Manual Change for Function Reference

Page 2-4, Options Available

Add following items:

Option 010, Extended Output Power Range

This option increases the output power range and adds power sweep capability.

Page 3-6, Specifications When Option is Installed

Add following item:

Specifications When Option 010 Extended Output Power Range is Installed

■ Output Power Characteristics

Range	-45 to +15 dBm
Resolution	0.2 dB
Level Accuracy (at 23±5°C, 0 dBm output level, 50 MHz)	±1 dB
Flatness (at 23±5°C, relative to 0 dBm output level at 50 MHz)	
100 k to 300 kHz	+3, -5 dB
300 k to 100 MHz	+2.5, -4.5 dB
100 M to 300 MHz	+3, -5 dB
Linearity (at 23±5°C, relative to 0 dBm output level at 50 MHz)	±1 dB

All of the above data is from the RF OUT 1 port when the RF OUT 2 port is terminated.

■ Spectral Purity Characteristics

Harmonics (at +15 dBm output level)	< -20 dBc
---	-----------

■ Power Sweep Characteristics

Maximum Span	60 dB
Resolution	0.1 dB

Page 8-2, **MENU** Key

Change Figure 8-2 to the following figure:

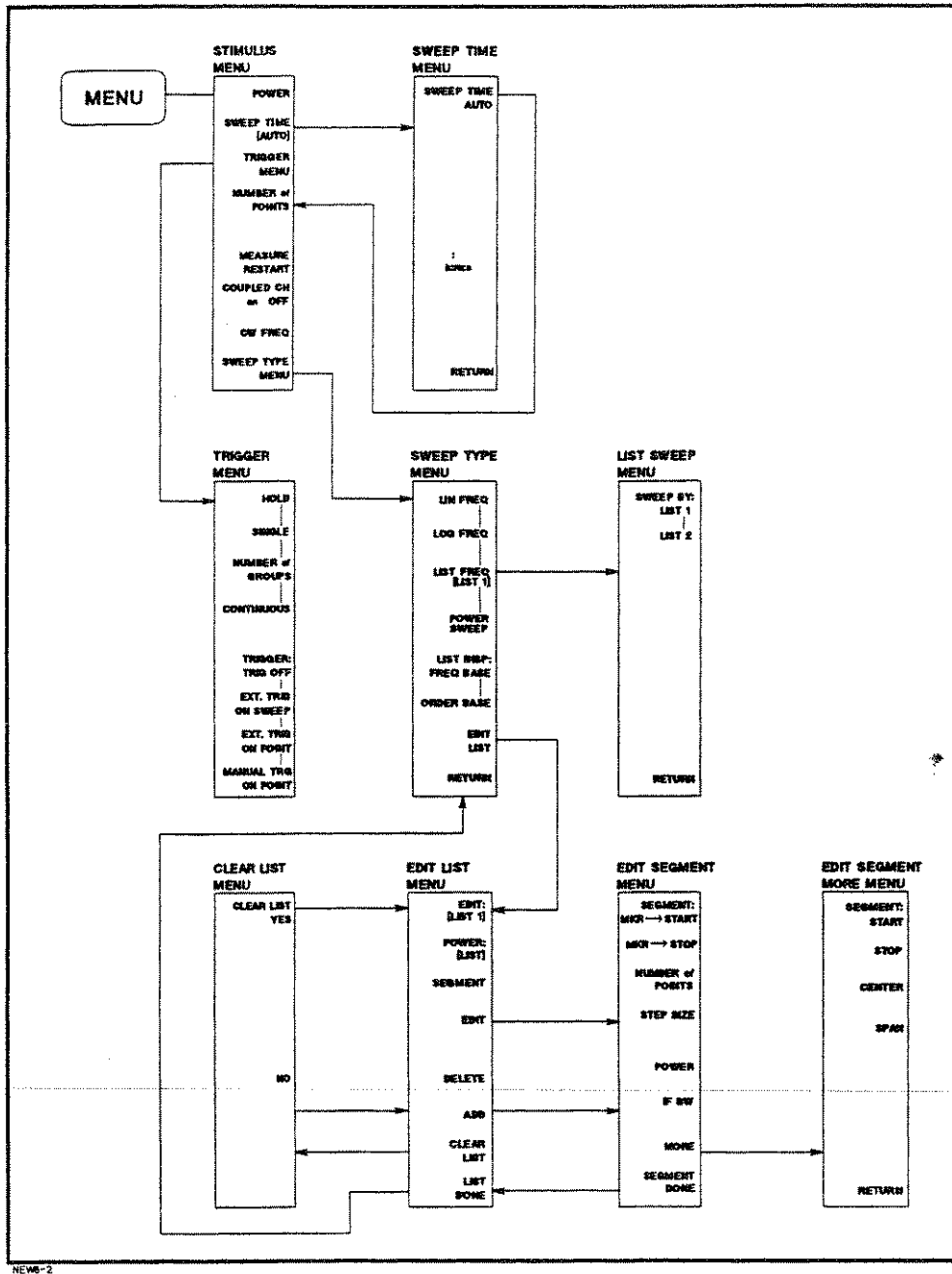

Figure 8-2. Softkey Menus Accessed from the **MENU** Key

Page 8-3, Stimulus Menu

Change Figure 8-3 to the following figure:

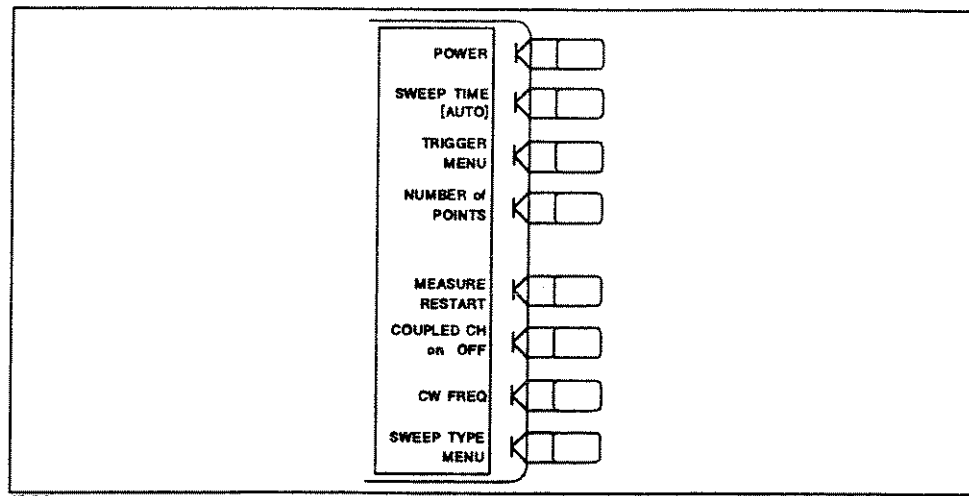

Figure 8-3. Stimulus Menu

Change as follows:

POWER (POWE) makes the power level the active function and activates the power menu, which sets the output power level. The allowable power range is -15 dBm to $+5$ dBm. When the option 010 is installed, the allowable power range becomes -50 dBm to $+20$ dBm. Default setting is 0 dBm. Setting resolution is 0.1 dBm.

Add following description:

CW FREQ (CWFREQ) sets the frequency for power sweep. (Option 010 only)

Page 8-7, Sweep Type Menu

Change as follows:

Four sweep types are available:

- Linear frequency sweeps in Hz
- Logarithmic frequency sweeps in Hz
- Power sweeps in dBm (Option 010 only)
- List frequency sweep in Hz. Two independent frequency sweep lists are available.

Change Figure 8-6 to the following figure:

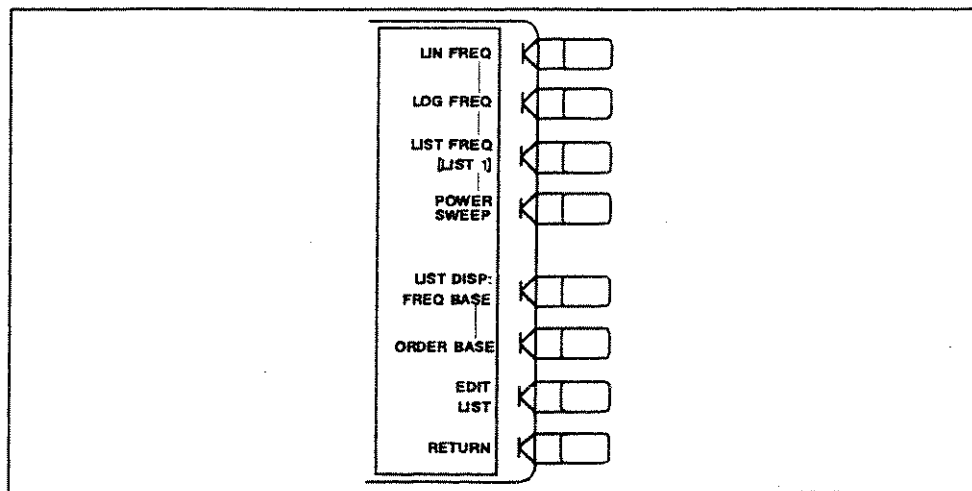

Figure 8-6. Sweep Type Menu

Add following description:

POWER SWEEP (POWS) activates a power sweep mode that characterizes power-sensitive DUTs. In this mode, power is swept at a single frequency, from a start power value to a stop power value, selected using the **START** and **STOP** keys and the entry block. This feature is convenient for measurements like gain compression or AGC (automatic gain control) slope. To set the power sweep frequency, use **CW FREQ** in the stimulus menu.

In power sweep, the entered sweep time may be automatically changed if it is less than the minimum time required for the current configuration (number of points, IF bandwidth, etc.).

This function is only available when the option 010 is installed.

Page 8-9, Edit List Menu

Change Figure 8-8 to the following figure:

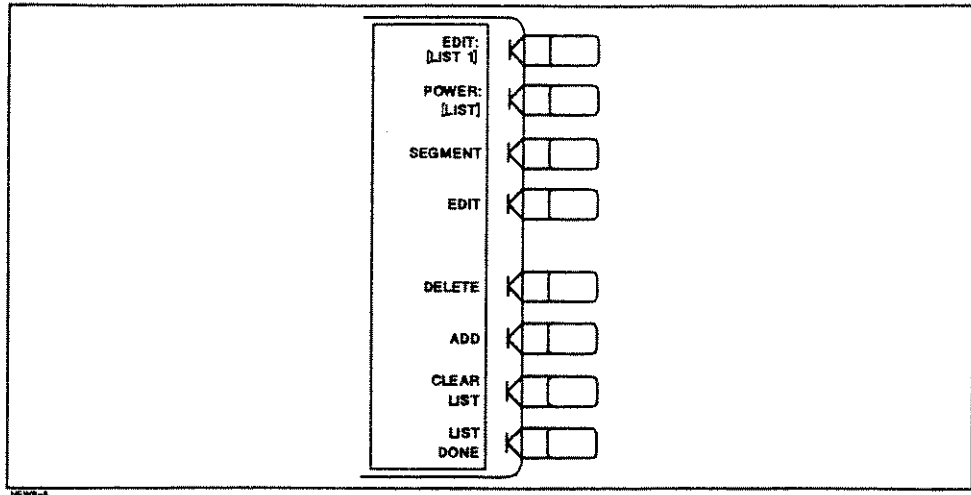

Figure 8-8. Edit List Menu

EDIT: [LIST 1] (EDITLIS1) or [LIST 2] (EDITLIS2) toggles between LIST 1 and LIST 2 for editing.

POWER: [LIST] (POWL) or [FIXED] (POWF) toggles the power setting being used when list sweep is performed. [LIST] selects the power setting in the list table, and [FIXED] selects the power set by **MENU** POWER key.

Page 8-10, Edit Segment Menu

Change as follows:

SEGMENT-POWER (POWE) sets power level in a list for segment by segment. The allowable range is -15 dBm to +5 dBm. When the option 010 is installed, the allowable power range becomes -50 dBm to +20 dBm.

Page 9-2, **MEAS** Key

Change Figure 9-2 to the following figure:

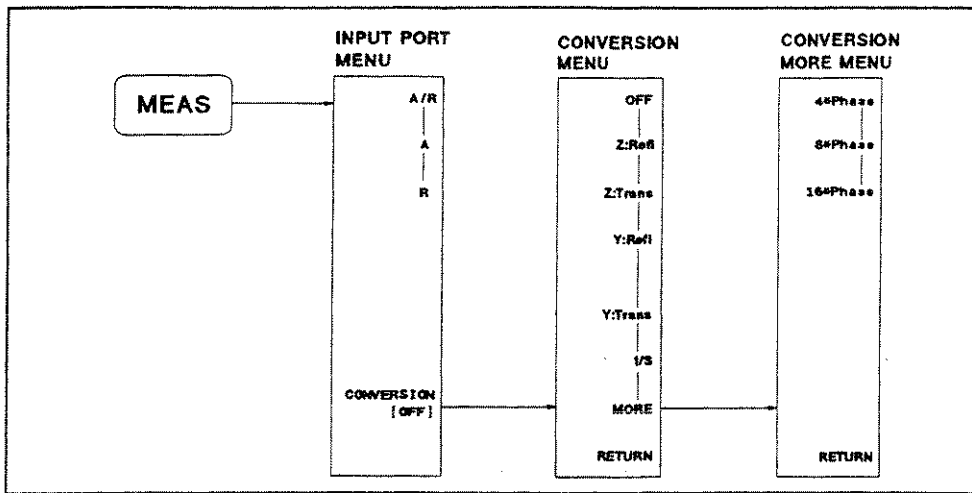

Figure 9-2. Softkey Menus Accessed from the **MEAS** Key

Page 9-3, Conversion Menu

Change as follows:

This menu converts the measured reflection or transmission data to the equivalent complex impedance (Z) or admittance (Y) values. This is not the same as a two-port Y or Z parameter conversion, as only the measured parameters are used in the equations. Two simple one-port conversions are available, depending on the measurement configuration.

An S_{11} or S_{22} trace measured as reflection can be converted to an equivalent parallel* impedance or admittance using the model and equations shown in Figure 9-4A.

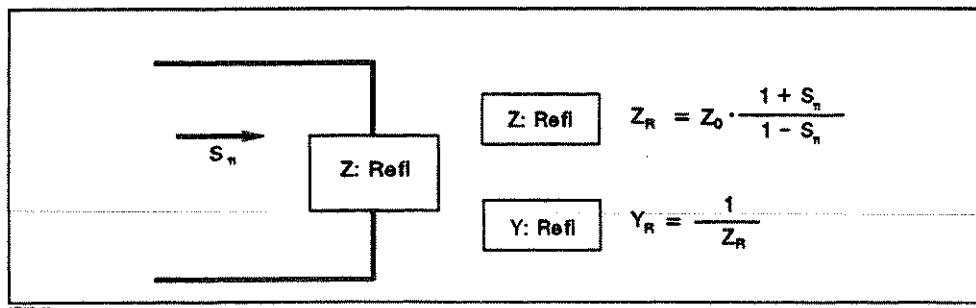

Figure 9-4A. Reflection Impedance and Admittance Conversions

In a transmission measurement, the data can be converted to its equivalent series impedance or admittance using the model and equations shown in Figure 9-4B.

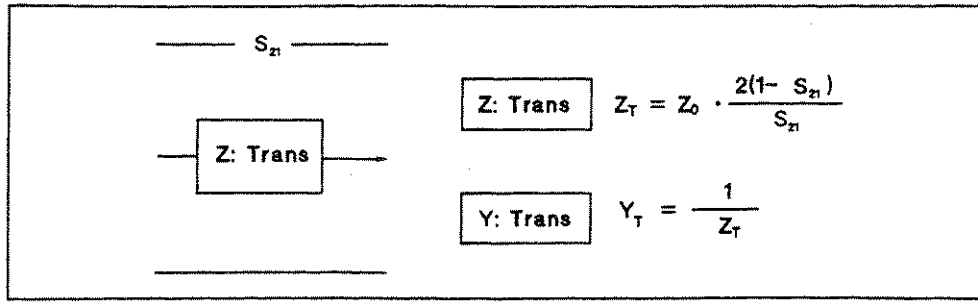

Figure 9-4B. Transmission Impedance and Admittance Conversions

Avoid using delay format for displaying Z and Y conversions, as these formats are not easily interpreted.

In all conversions except for “1/S”, marker values are impedance values in Ω units for Z conversions, or admittance values in S units for Y conversions in any format. The unit is displayed as “U” on CRT.

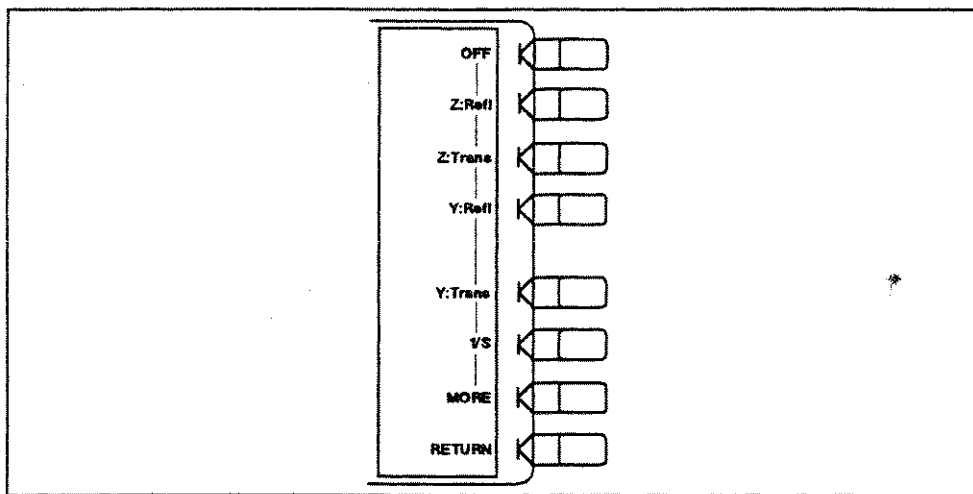

Figure 9-5A. Conversion Menu

OFF (CONVOFF) turns off all the parameter conversion operations.

Z: Refl (CONVZREF) converts the reflection data to its equivalent impedance values.

Z: Trans (CONVZTRA) converts the transmission data to its equivalent impedance values.

Y: Refl (CONVYREF) converts the reflection data to its equivalent admittance values.

Y: Trans (CONVYTRA) converts the transmission data to its equivalent admittance values.

1/S (CONV1DS) expresses the data in inverse S-parameter values, ideal for use in amplifier and oscillator design.

MORE provides the Conversion More menu described in the next section.

RETURN returns to the previous menu, the input ports menu.

Conversion More Menu

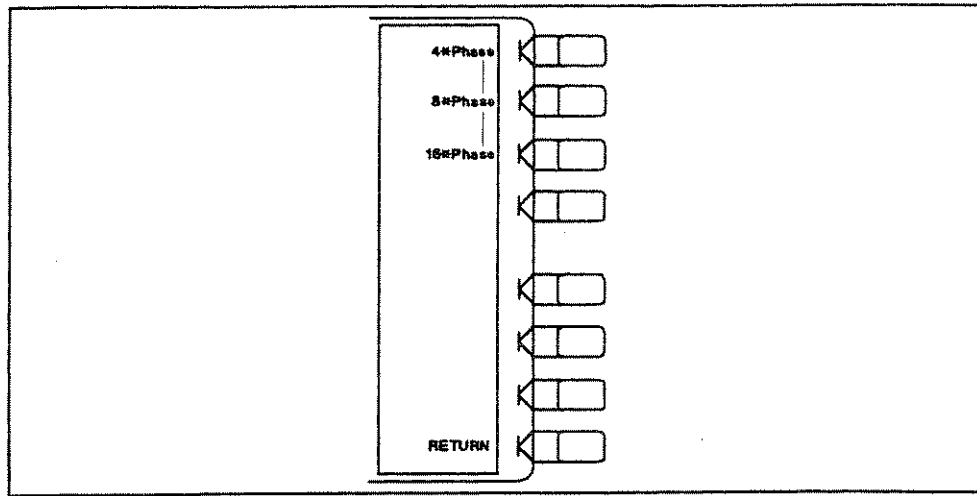

Figure 9-5B. Conversion More Menu

4*phase (CONVMP4) multiplies phase data by a factor of 4.

8*phase (CONVMP8) multiplies phase data by a factor of 8.

16*phase (CONVMP16) multiplies phase data by a factor of 16.

RETURN returns to the conversion menu.

Page 9-25, Special Function Menu

EQUIVALENT CKT (EQUCPARA?) derives parameters for the equivalent circuit used for a crystal resonator, within the frequency range specified by **ANALY MIN** and **ANALY MAX**. The equivalent circuit is shown in Figure 9-38.

When a measured data is not applicable for the equivalent circuit model, then "0" will be returned for all parameters.

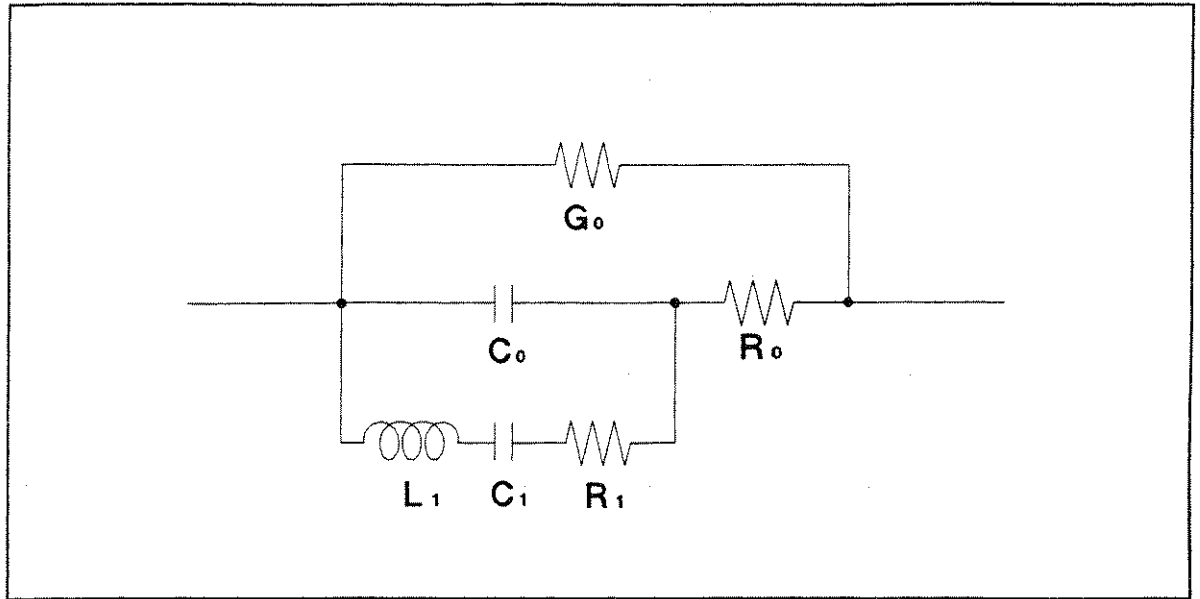

CASME501

Figure 9-38. Six-Device Equivalent Circuit for Crystal Resonator

Page 14-2, File Type and Data Saved

Add following note:

Note



It is not possible to recall the instrument status file that is saved by a revision 2.0 instrument by a revision 1.0 instrument. The revision 2.0 can read the instrument setting file of the revision 1.0. When you use the same instrument setting file for the revision 1.0 and 2.0, use the setting file that is saved by the revision 1.0.

Page B-1, Preset State

Add following item to table B-1:

Table B-1. Preset Conditions

Operating Parameter	Initialization Method	
	Power-On	PRESET key
Frequency List		
Power Setting	LIST	LIST

Page E-1. Stimulus Block

Change Figure E-1 to the following figure:

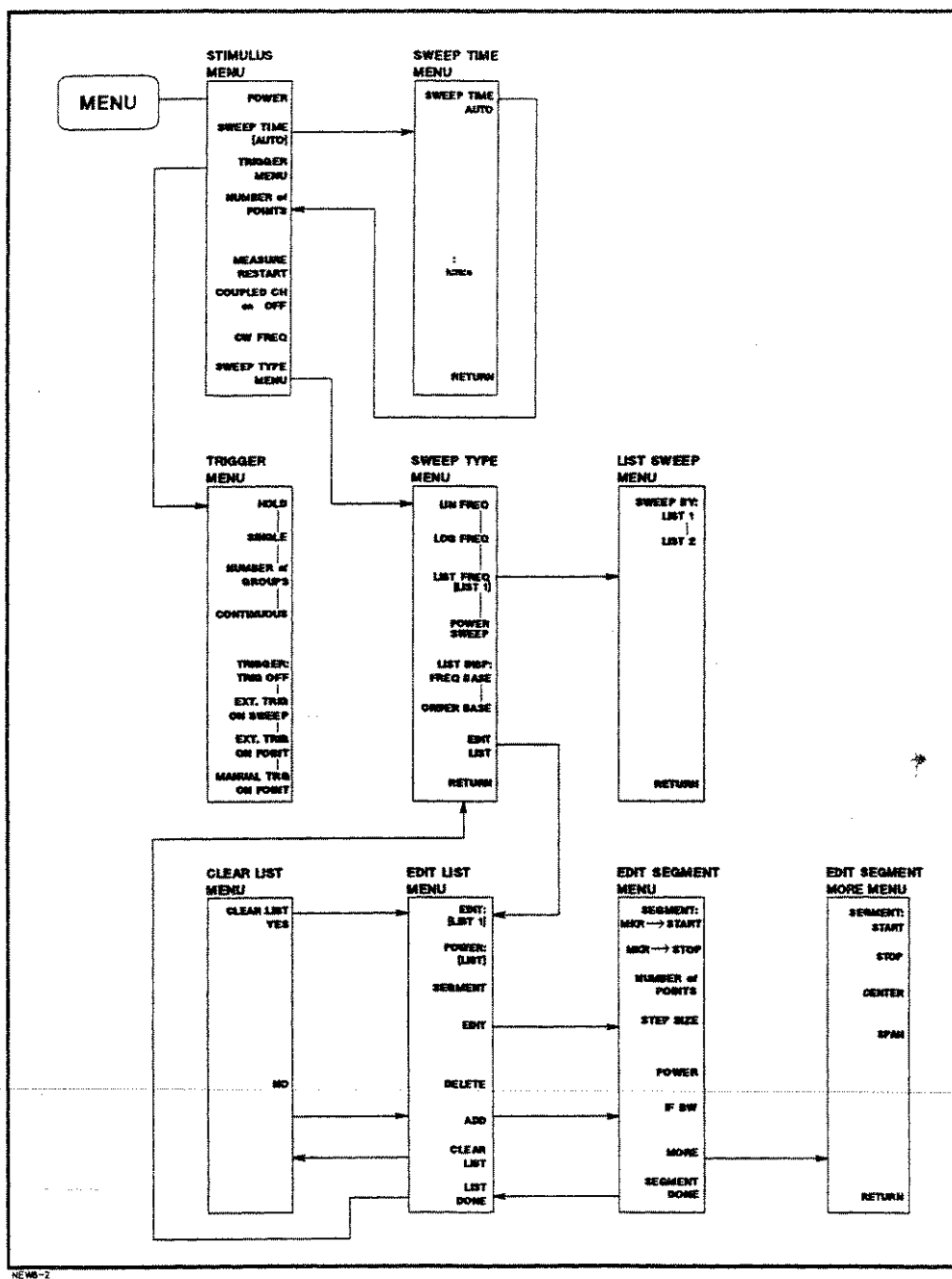

Figure E-1. **MENU** Key

Change Figure E-2 to the following figure:

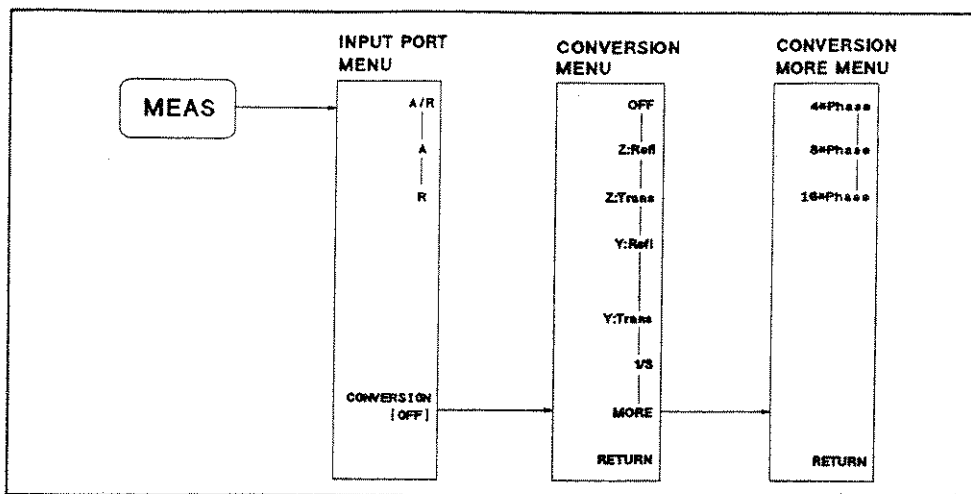

Figure E-2. **MEAS** Key

Page Message-1, Error Messages

Add following error messages to Error Message List.

31 NOT AVAILABLE FOR THIS FORMAT

Command, DISPDATM, is not valid when the format is either LOG MAG & Phase, or LOG MAG & Delay.

204 POWER ON TEST FAILED

The power on test is failed.

246 INSUFFICIENT MEMORY

A large COM variable has been made by the Instrument BASIC and the system memory is not large enough for the operation.

BUS ERROR

Instrument needs the adjustment or the repair. Contact your local Hewlett-Packard service center or sales office.

ADDRESS ERROR

Instrument needs the adjustment or the repair. Contact your local Hewlett-Packard service center or sales office.

ILLEGAL INSTRUCTION

Instrument needs the adjustment or the repair. Contact your local Hewlett-Packard service center or sales office.

DIVIDE BY ZERO

Instrument needs the adjustment or the repair. Contact your local Hewlett-Packard service center or sales office.

PRIVILEGE VIOLATION

Instrument needs the adjustment or the repair. Contact your local Hewlett-Packard service center or sales office.

FATAL ERROR: can't alloc memory

Instrument needs the adjustment or the repair. Contact your local Hewlett-Packard service center or sales office.

FP ERROR any OCCURRED , IN any AT xxxxxxxxH

This message is displayed when the HP 87510A, or a user operation has any problem. Contact your local Hewlett-Packard service center or sales office.

FATAL ERR:No response from A2 CPU, ACK not asserted

Instrument needs the adjustment or the repair. Contact your local Hewlett-Packard service center or sales office.

FATAL ERR:No response from A2 CPU, ACK not negated

Instrument needs the adjustment or the repair. Contact your local Hewlett-Packard service center or sales office.

FATAL ERROR:duplicate sweep trigger

Instrument needs the adjustment or the repair. Contact your local Hewlett-Packard service center or sales office.

FATAL ERROR occurred on A2 CPU

Instrument needs the adjustment or the repair. Contact your local Hewlett-Packard service center or sales office.

Manual Changes for HP-IB Command Reference

Changed HP-IB Commands

The following commands have been changed from firmware revision 2.0:

EQUCPARA?
 EQUCPARS?
 POWE *value*

EQUCPARA?

Executes the six-device equivalent circuit analysis for a resonator, then outputs parameters, C_0 , C_1 , L_1 , R_1 , G_0 , and R_0 . For more information, refer to "EQUCPARA?" in Chapter 4. (Data format: C_0 , C_1 , L_1 , R_1 , G_0 , R_0)

(**EQUIVALENT GKT** under **SPCL FCTN**); Query only)

EQUCPARS?

Executes the six-device equivalent circuit analysis for a resonator, then outputs parameters, C_0 , C_1 , L_1 , R_1 , f_s , f_a , f_r , f_1 , f_2 , G_0 , and R_0 . For more information, refer to "EQUCPARS?" in Chapter 4. (Data format: C_0 , C_1 , L_1 , R_1 , f_s , f_a , f_r , f_1^* , f_2^* , G_0 , R_0)

* $f_1 < f_2$

POWE *value* [dBm]

Sets the source output level.

(**POWER** under **MENU**); Query)

value -15 to +5 (dBm)
 -50 to +20 (dBm) (Option 010 only)

New HP-IB Commands

The following commands have been added to the HP 87510A with firmware revision 2.0.

ATTN{0DB|20DB|40DB}
CONVYREF
CONVZREF
CWFREQ *value*
EQUCO? *value*
EQUM *value*
ERRH{ON|OFF}
OUTPCERR?
POWF
POWL
POWO?
POWS
SERM?

ATTN{0DB|20DB|40DB}

Sets the power attenuator value to 0 dB, 20 dB or 40 dB.

(Under SERVICE MENU under **SYSTEM**)

CONVYREF

Converts the reflection data to its equivalent admittance values.

(Y: Ref1 under **MEAS**; Query)

CONVZREF

Converts the reflection data to its equivalent impedance values.

(Z: Ref1 under **MEAS**; Query)

CWFREQ *value* [*suffix*]

Sets the frequency for power sweep. (Option 010 only)

(CWFREQ under **MENU**; Query)

value 10^3 to 3.0×10^8 (Hz)

suffix See "Suffix" of the *HP-IB Programming Manual*.

EQUCO? *value* [*suffix*]

Returns a C_0 at the specified frequency. For more information about EQUCO?, see "EQUCO? *value*" in Chapter 4.

value 10^3 to 3.0×10^8 (Hz)

suffix See "Suffix" of the *HP-IB Programming Manual*.

EQUM *value*

Specifies how many points are used for an approximation of a circle for EQUCPARA? and EQUCPARS? command. The default value is 8. For a detail information about EQUM, refer to "EQUCPARA?" in Chapter 4.

value Integer: 2 to 801

ERRH{ON|OFF}

Select whether halting or rebooting instrument when a system error has occurred. If ERRHON is sent, instrument will stop all functions when the system error is occurred. If ERRHOFF is sent, instrument will reboot when the system error is occurred. Default setting is ERRHOFF. For more information, see *Service Manual*.

OUTPCERR?

Outputs ceramic resonator parameters. For information about each parameter, see "OUTPCERR?" in Chapter 4. (Data format: G_r , F_r , G_a , F_a , rpl_1 , rpl_2 , rpl_3)

POWF

Selects the fixed power which is set by **MENU POWER** key or POWE command when a list sweep being performed. To use a power set in list table, send a POWL command. The default setting is POWL. (**POWER [FIXED]** under **MENU**); Query)

POWL

Selects the power which is set in the list table when a list sweep being performed. You can also select fixed power setting which is set in **MENU POWER** by sending a POWF command. The default setting is POWL. (**POWER [LIST]** under **MENU**); Query)

POWO?

Verifies whether the option 010 extended output power range is installed or not. If power sweep options is installed, query operation returns a string; "010". If not installed, query returns "STD". (Query only)

POWS

Select the sweep type to the power sweep. (Option 010 only)

(**POWER SWEEP** under **MENU**); Query)

SERM?

Verifies whether the service mode is ON or OFF. If the service mode of channel 1 and 2 is turned off, a SERM? returns 0, or other case, returns 1. This command has no correspondent softkey. For more information, see *Service Manual*. (Query only)



Added and Changed Waveform Analysis Commands

This chapter provides a brief description for the waveform analysis commands which are added to the firmware revision 2.0. This chapter corresponds to the appendix E of the *HP-IB Programming Manual*.

Following commands are added or changed from revision 2.0:

- EQUCPARA?
- EQUCPARS?
- EQU
- EQUCO?
- OUTPCERR?

EQUCPARA?

Outputs six-device equivalent circuit parameters of the crystal resonator; C_0 , C_1 , L_1 , R_1 , G_0 , R_0 .

Syntax

EQUCPARA?

This command is query only.

Query Response

C_0 , C_1 , L_1 , R_1 , G_0 , R_0

Each term represents equivalent circuit as shown below:

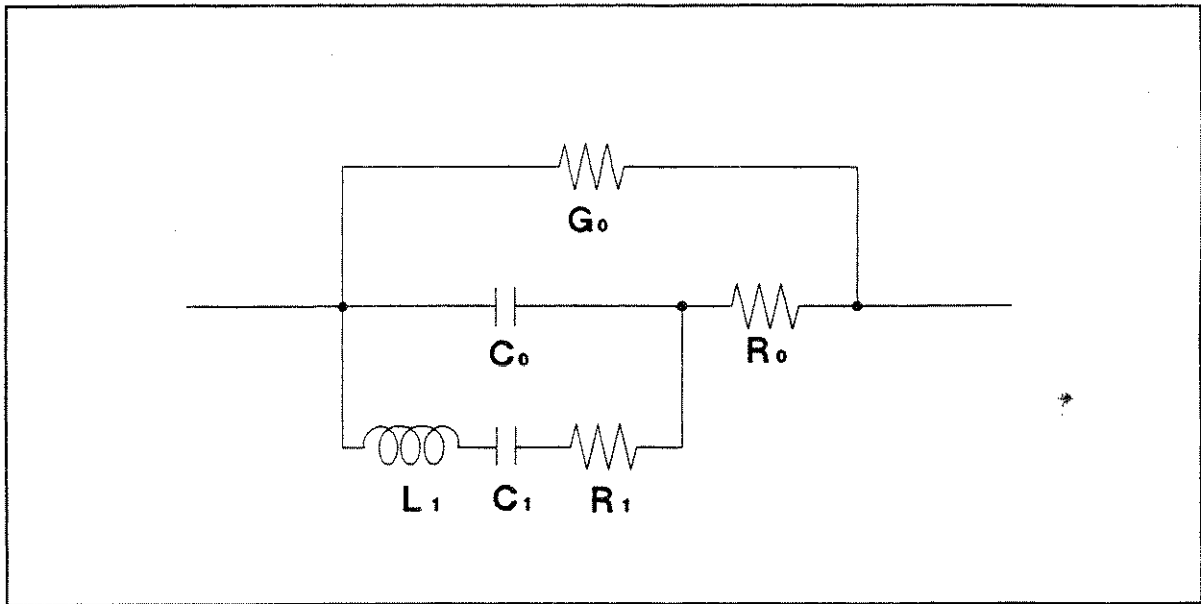

Figure 4-1. Six-Device Equivalent Circuit of Resonator

Descriptions

When EQUCPARA? is sent, instrument performs followings:

1. Obtains the admittance characteristic circle diagram.
2. Obtains the maximum conductance (G_{max}).
3. Obtains frequencies f_1 and f_2 ($f_1 < f_2$) of two points where the conductance is half the maximum conductance (G_{max}).
4. Calculate f_s by $f_s = \sqrt{f_1 \times f_2}$.
5. Obtains susceptance B_{fs} at f_s .
6. Calculate ω_s by $\omega_s = 2 \times \pi \times f_s$.
7. Assumes that the frequency at which the phase becomes 0° near the parallel resonance frequency is f_a , and obtains its conductance G_a .
8. Calculate ω_a by $\omega_a = 2 \times \pi \times f_a$.

9. Assumes that the frequency at which the phase becomes 0° * near the series resonance frequency is f_r .
10. Calculates the constants using the above values and the following equations:

$$\begin{aligned}
 Q_s &= \frac{f_s}{f_2 - f_1} & C_o' &= \frac{B_1 + B_2}{2\omega_s} \\
 L_1 &= \frac{Q_s}{\omega_s G_{max}} & R_1 &= \frac{C_o'}{C_o G_{max}} \\
 C_1 &= \frac{G_{max}}{\omega_s Q_s} & R_o &= \frac{1}{G_{max}} - R_1 \\
 C_o &= \frac{B f_s}{\omega_s} & G_o &= G_a - \frac{R_1 \omega_a^2 C_o^2}{1 + R_o R_1 \omega_a^2 C_o^2}
 \end{aligned}$$

* EQUCPARA? interpolates the 0° phase points even if it does not exist in measured data.

If the number of points between the maximum peak point (f_{Bmax}) and the minimum peak point (f_{Bmin}) of the conductance is less than 10 points, EQUCPARA? approximates an admittance circle. The circle approximation can be performed if there are 3 points for analyze. You can specify how many points are used for circle approximation by using EQUM command for reducing the analysis time.

If EQUCPARA? fails a circle approximation, 0 will be return for all parameters.

If there are only 2 points for analysis, EQUCPARA? returns four-device equivalent circuit parameters. In this case, EQUCPARA? returns 0 for G_o and R_o .

If there is only 1 point for analysis, EQUCPARA? returns 0 for all parameters.

EQUM value

Specifies how many points are used for an approximation of a circle for EQUCPARA? and EQUCPARS? command. EQUCPARA? (or EQUCPARS?) thins the measured points out for the specified points, then make circle approximation. When the EQUM parameter is set greater than the number of points, EQUCPARA? uses all points for the circle approximation. Default value is 8.

value 2 to 801

Notes

This command is only available when the LOG MAG & Phase, or Polar format is selected. If the other format is selected, 0 will be returned for query response.

This command can be invoked with the EXECUTE command of Instrument BASIC.

Example

For the external controller:

10	OUTPUT 717;"POLA"	<i>Set to POLAR format.</i>
100	OUTPUT 717;"EQUCPARA?"	<i>Send the EQUCPARA? query to the HP 87510A.</i>
110	ENTER 717;C0,C1,L1,R1,GO,RO	<i>Receive the equivalent circuit parameters.</i>
120	PRINT "C0=",C0,"C1=",C1	<i>Display the equivalent circuit parameter</i>
130	PRINT "L1=",L1,"R1=",R1	<i>on the CRT.</i>
140	PRINT "GO=",GO,"RO=",RO	
150	END	

EQUCPARA?

For Instrument BASIC:

10	OUTPUT 800;"POLA"	<i>Set to POLAR format.</i>
20	EXECUTE "SING"	<i>Make a single sweep.</i>
100	WRITEIO 8,0;4	<i>Put the parameter of EQU on a register.</i>
101	!	<i>You must put the command parameter on the register</i>
102	!	<i>before you use the EXECUTE command.</i>
110	EXECUTE "EQU"	<i>Invoke the EQU command.</i>
111	!	<i>The EXECUTE runs the command faster</i>
112	!	<i>than the OUTPUT statement</i>
120	EXECUTE "EQUCPARA?"	<i>Invoke the EQUCPARA? query.</i>
130	CO=READIO(8,0)	<i>Read the first return value from the register.</i>
131	!	<i>HP 87510A returns the query response</i>
132	!	<i>to the register.</i>
140	C1=READIO(8,1)	<i>Read the second return value.</i>
150	PRINT "CO=",CO,"",C1=",C1	<i>Display the equivalent circuit parameters.</i>
160	L1=READIO(8,2)	<i>Read the third return value.</i>
170	R1=READIO(8,3)	<i>Read the fourth return value.</i>
180	PRINT "L1=",L1,"",R1=",R1	<i>Display the rest of query response.</i>
190	END	

EQUCPARS?

Outputs six-device equivalent circuit parameters of the crystal resonator; C_0 , C_1 , L_1 , R_1 , f_s , f_a , f_r , f_1^* , f_2^* , G_0 , R_0 .

Syntax

EQUCPARS?

Query Response

C_0 , C_1 , L_1 , R_1 , f_s , f_a , f_r , f_1^* , f_2^* , G_0 , R_0

* $f_1 < f_2$

For information about each parameter, refer to "EQUCPARA?".

Notes

This command is only available when the LOG MAG & Phase, or Polar format is selected. If the other format is selected, 0 will be returned for query response.

This command can be invoked with the EXECUTE command of Instrument BASIC.

EQUCO?

Returns C_0 of the equivalent circuit of the resonator at specified frequency.

Syntax

EQUCO? *value* [*suffix*]

Where,

value 10^3 to 3.0×10^8 (Hz)
suffix HZ (KHZ, MHZ, GHZ are also available)

This command is query only.

Query Response

C_0

Description

C_0 is calculated by using the following equation:

$$C_0 = \frac{B_s}{\omega_s}$$

Where,

B_s Imaginary part on f_s
 ω_s $2 \times \pi \times f_s$
 f_s Frequency which is specified as command parameter

If Z-conversion is selected, C_0 is calculated by using following equations:

$$C_0 = \frac{-1}{B_s \times \omega_s}$$

Notes

This command is only available when LOG MAG & Phase or Polar format is selected. If another format is selected, 0 will be returned. If the specified frequency is out of analysis range, 0 will be returned.

If B_s is 0 when the Z-conversion is activated, EQUCO? returns 0.

This command can be invoked with the EXECUTE command of Instrument BASIC.

Example

For the external controller:

```
100 OUTPUT 717;"EQUCO? 100MHZ"    Query  $C_0$  at 100 MHz.  
110 ENTER 717;CO                    Receive the returned  $C_0$ .  
120 PRINT "CO=",CO                  Display  $C_0$  on the CRT.  
130 END
```

For Instrument BASIC:

```
100 WRITEIO 8,0;1.E+8 Put the command parameter, 100 MHz, on the register.
110 EXECUTE "EQUCO?" Invoke the EQUCO? query.
120 CO=READIO(8,0) Read a return value and enter to the variable CO.
130 PRINT "CO=",CO Display C0 on the CRT.
140 END
```

OUTPCERR?

Outputs the ceramic resonator parameters; G_r , f_r , G_a , f_a , rpl_1 , rpl_2 , rpl_3 .

Syntax

OUTPCERR?

This command is query only.

Query Response

G_r , f_r , G_a , f_a , rpl_1 , rpl_2 , rpl_3

Where,

G_r	Gain at f_r
f_r	Resonant frequency
G_a	Gain at f_a
f_a	Anti-resonant frequency
rpl_1	Maximum ripple height in left side of resonant point
rpl_2	Maximum ripple height between resonant and anti-resonant point
rpl_3	Maximum ripple height in right side of anti-resonant point

Description

When OUTPCERR? is sent, instrument performs followings:

1. Searches for the minimum peak in the analysis range, then returns its gain G_r and frequency f_r .
2. Searches for the maximum peak in the analysis range, then returns its gain G_a and frequency f_a .
3. Sets the end point of the analysis range to f_r .
4. Searches the maximum height of the local maximum and the adjacent left-hand local minimum within range, then outputs as rpl_1 .
5. Sets the start of the analysis range to f_r , and the end of the analysis range to f_a .
6. Searches the maximum height of the local maximum and the maximum value of the adjacent right-hand local minimum which are between the resonant and anti resonant points, then outputs as rpl_2 .
7. Sets the start of the analysis range to f_a , and the end of the analysis range to the frequency that was initial setting.
8. Searches the maximum value of difference between the local maximum and the maximum value of the adjacent left-hand local minimum which are at the right of the resonant point, then outputs as rpl_3 .

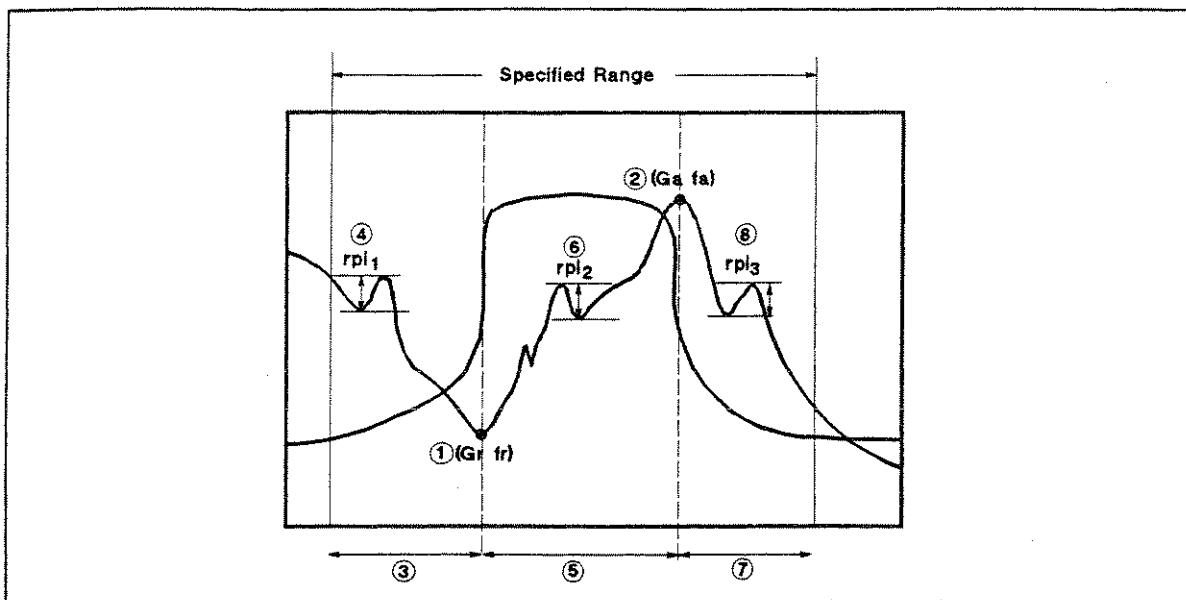

Figure 4-2. OUTPCERR?

Notes

This command is only available when the following formats are selected;

- LOG MAG & Phase
- LOG MAG & Delay
- LOG MAG

If another format is selected, the query returns 0.

If Z-conversion is selected, then the Z_r instead of the G_r and the Z_a instead of the G_a are returned.

Where,

Z_r Impedance at f_r

Z_a Impedance at f_a

If OUTPCERR? could not find any ripples, the query returns 0.

This command can be invoked with the EXECUTE command of Instrument BASIC.

Example

For the external controller:

```

100 OUTPUT 717;"OUTPCERR?"           Query the ceramic resonator parameters.
110 ENTER 717;Gr,Fr,Ga,Fa,Rpl1,Rpl2,Rpl3  Receive the all return value.
120 PRINT Gr,Fr,Ga,Fa,Rpl1,Rpl2,Rpl3    Display the result.
130 END

```

For Instrument BASIC:

```

100 EXECUTE "OUTPCERR?"              Invoke the OUTPCERR? query.
110 PRINT "Gr=",READIO(8,0)          Display the part of return value.
120 END

```



DECLARATION OF CONFORMITY

according to ISO/IEC Guide 22 and EN 45014

Manufacturer's Name: Yokogawa-Hewlett-Packard, LTD.

Manufacturer's Address: 9-1, Takakura-cho, Hachioji-shi, Tokyo, 192 Japan

declares, that the product

Product Name : Gain Phase Analyzer

Model Number(s) : HP 87510A

Product Options : This declaration covers all options of the above product.

conforms to the following Product Specifications :

Safety : HD-401 / IEC 348

EMC : EN 55011 (1991) / CISPR-11 Group 1, Class A
EN 50082-1 (1991) / IEC 801-2 4 kV CD, 8 kV AD
EN 50082-1 (1991) / IEC 801-3 (DRAFT), 3 V/m
EN 50082-1 (1991) / IEC 801-4 1 kV

Supplementary Information :

The product was tested in a typical configuration with Yokogawa-Hewlett-Packard.

Tokyo, Japan
Location

February 1, 1992
Date

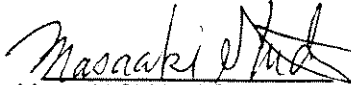
Masaaki Shida / QA Manager



Herstellerbescheinigung

Hiermit wird bescheinigt, daß das Gerät HP 87510A Gain-Phase Analyzer in Übereinstimmung mit den Bestimmungen von Postverfügung 1046/84 funkentstört ist.

Der Deutschen Bundespost wurde das Inverkehrbringen dieses Gerätes angezeigt und die Berechtigung zur Überprüfung der Serie auf Einhaltung der Bestimmungen eingeräumt.

Anm: Werden Meß- und Testgeräte mit ungeschirmten Kabeln und/oder in offenen Meßaufbauten verwendet, so ist vom Betreiber sicherzustellen, daß die Funk-Entstörbestimmungen unter Betriebsbedingungen an seiner Grundstücksgrenze eingehalten werden.

GERÄUSCHEMISSION

Lpa < 70 dB
am Arbeitsplatz
normaler Betrieb
nach DIN 45635 T. 19

Manufacturer's Declaration

This is to certify that this product, the HP 87510A Gain-Phase Analyzer, meets the radio frequency interference requirements of directive 1046/84. The German Bundespost has been notified that this equipment was put into circulation and was granted the right to check the product type for compliance with these requirements.

Note: If test and measurement equipment is operated with unshielded cables and/or used for measurements on open set-ups, the user must insure that under these operating conditions, the radio frequency interference limits are met at the border of his premises.

ACOUSTIC NOISE EMISSION

Lpa < 70 dB
operator position
normal operation
per ISO 7779

1

2

3

4

5

6

7

8

9

10

11

12

13

14

15

16

17

18

19

20

Documentation Map

Operation Manual Set (HP Part Number 87510-90000)

Reference Manual

The *Reference Manual* provides in-depth reference information, general information, and specifications.

HP-IB Programming Manual

The *HP-IB Programming Manual* provides a summary of all available HP-IB command, and shows how to make basic program to control the HP 87510A by a controller by HP-IB.

Using HP Instrument BASIC with the HP 87510A

The *Using HP Instrument BASIC with the HP 87510A* describes how HP Instrument BASIC works with the HP 87510A and any unique features.

Maintenance Manual (HP Part Number 87510-90030)

The *Maintenance Manual* explains how to verify conformance to published specifications.

Service Manual (Option 0B3), (HP Part Number 87510-90031)

The *Service Manual* explains how to adjust, troubleshoot, and repair the instrument.

HP Instrument BASIC HP Instrument BASIC Users Handbook (Option 002 only), (HP Part Number E2083-90000)

HP Instrument BASIC Programming Techniques

HP Instrument BASIC Interfacing Techniques

These two provide some helpful hints on getting the most use from HP Instrument BASIC programming language, and provide a general programming reference. This manual is furnished option 002.

HP Instrument BASIC Language Reference

The HP Instrument BASIC Language Reference provides a summary of all available HP Instrument BASIC Language. This manual is furnished option 002.

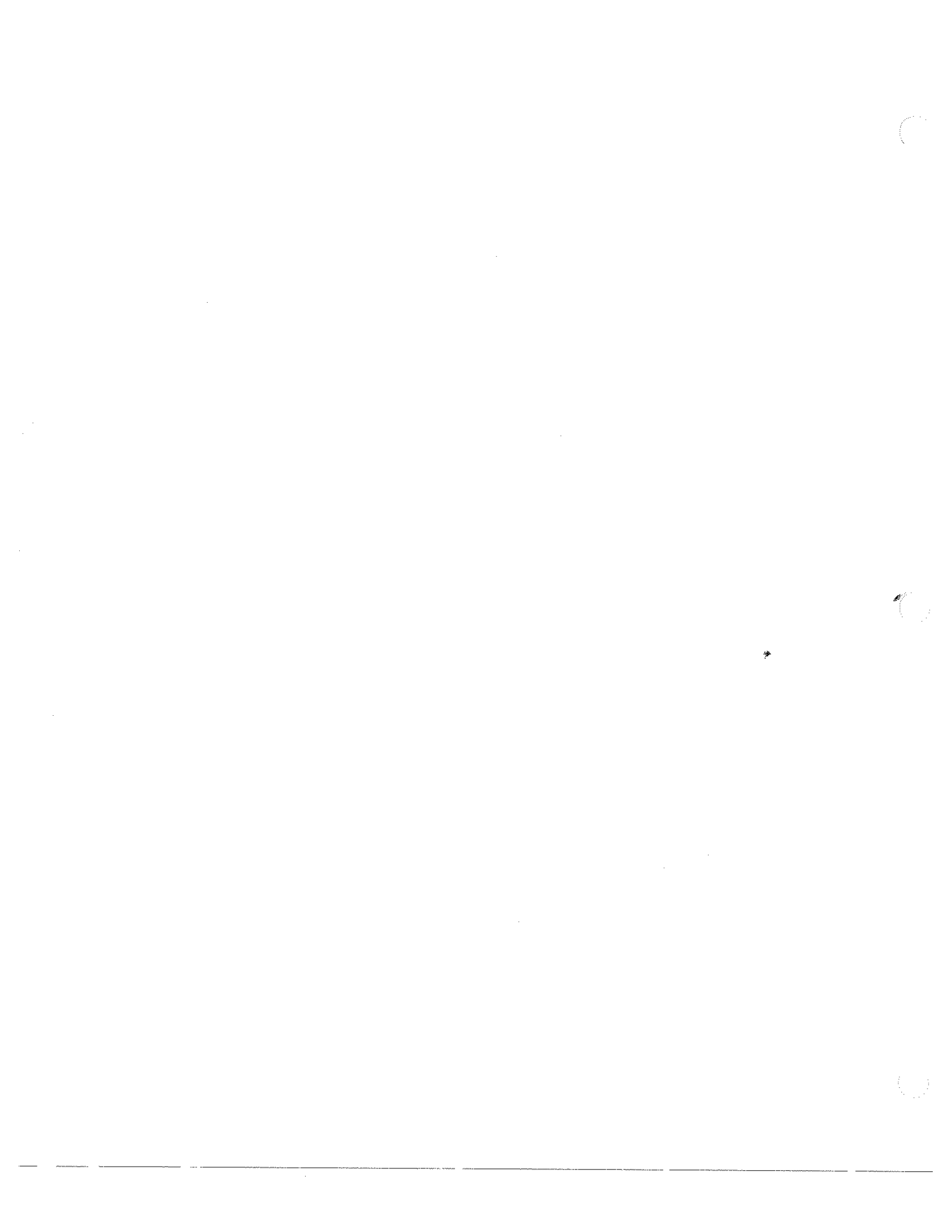

HP 87510A GAIN-PHASE ANALYZER OPERATION MANUAL

SERIAL NUMBERS

This manual applies directly to instruments with serial number prefix 3125J.
For additional important information about serial numbers, read "Instruments
Covered by This Manual" in Chapter 2 of the Reference Manual.



HP Part No. 87510-90000
Microfiche Part No. 87510-90050
Printed in JAPAN December 1991

Notice

The information contained in this document is subject to change without notice.

This document contains proprietary information which is protected by copyright. All rights are reserved. No part of this document may be photocopied, reproduced, or translated to another language without the prior written consent of the Hewlett-Packard Company.

Yokogawa-Hewlett-Packard, LTD.
Kobe Instrument Division
9-1, Takakura-cho, Hachioji-shi,
Tokyo, 192 Japan

Manual Printing History

The manual printing date and part number indicate its current edition. The printing date changes when a new edition is printed. (Minor corrections and updates which are incorporated at reprint do not cause the date to change.) The manual part number changes when extensive technical changes are incorporated.

December 1991..... 1st. Edition

Safety Summary

The following general safety precautions must be observed during all phases of operation, service, and repair of this instrument. Failure to comply with these precautions or with specific **WARNINGS** given elsewhere in this manual violates safety standards of design, manufacture, and intended use of the instrument.

The Hewlett-Packard Company assumes no liability for the customer's failure to comply with these requirements.

Ground The Instrument

This is a Safety Class 1 product (provided with a protective earthing terminal). An uninterruptible safety earth ground must be provided from the main power source to the product input wiring terminals, power source to the product input wiring terminals, power cord, or supplied power cord set. Whenever it is likely that the protection has been impaired, the product must be made inoperative and secured against any unintended operation.

DO NOT Operate In An Explosive Atmosphere

Do not operate the instrument in the presence of flammable gasses or fumes. Operation of any electrical instrument in such an environment constitutes a safety hazard.

Keep Away From Live Circuits

Operating personnel must not remove instrument covers. Component replacement and internal adjustments must be made by qualified maintenance personnel. Do not replace components with the power cable connected. Under certain conditions, dangerous voltages may exist even with the power cable removed. To avoid injuries, always disconnect power and discharge circuits before touching them.

DO NOT Service Or Adjust Alone

Do not attempt internal service or adjustment unless another person, capable of rendering first aid and resuscitation, is present.

DO NOT Substitute Parts Or Modify Instrument

Because of the danger of introducing additional hazards, do not substitute parts or perform unauthorized modifications to the instrument. Return the instrument to a Hewlett-Packard Sales and Service Office for service and repair to ensure the safety features are maintained.

Dangerous Procedure Warnings

Warnings, such as the example below, precede potentially dangerous procedures throughout this manual. Instructions contained in the warnings must be followed.

Warning



Dangerous voltages, capable of causing death, are present in this instrument. Use extreme caution when handling, testing, and adjusting this instrument.

How To Use This Manual

This is the Operating Manual for the HP 87510A Gain-Phase Analyzer. This manual contains specifications, installation, configuration, and operation in the procedure following documentations. After you receive your HP 87510A, begin with chapter 1. of Users Guide.

For error messages of the HP 87510A, refer to Error Message in the Operation Manual.

Typeface Conventions

Bold Boldface type is used when a term is defined. For example: **icons** are symbols.

Italics Italic type is used for emphasis and for titles of manuals and other publications.

Italic type is also used for keyboard entries when a name or a variable must be typed in place of the words in italics. For example: copy *filename* means to type the word *copy*, to type a space, and then to type the name of a file such as *file1*.

Computer Computer font is used for on-screen prompts and messages.

HARDKEYS Labeled keys on the instrument front panel are enclosed in □.

SOFTKEYS Softkeys located to the right of the CRT are enclosed in ▢.

Certification

Hewlett-Packard Company certifies that this product met its published specifications at the time of shipment from the factory. Hewlett-Packard further certifies that its calibration measurements are traceable to the United States National Institute of Standards and Technology, to the extent allowed by the Institution's calibration facility, or to the calibration facilities of other International Standards Organization members.

Warranty

This Hewlett-Packard instrument product is warranted against defects in material and workmanship for a period of one year from the date of shipment, except that in the case of certain components listed in *General Information* of this manual, the warranty shall be for the specified period. During the warranty period, Hewlett-Packard Company will, at its option, either repair or replace products which prove to be defective.

For warranty service or repair, this product must be returned to a service facility designated by HP. Buyer shall prepay shipping charges to HP and HP shall pay shipping charges to return the product to Buyer. However, Buyer shall pay all shipping charges, duties, and taxes for products returned to HP from another country.

HP warrants that its software and firmware designated by HP for use with an instrument will execute its programming instruction when properly installed on that instrument. HP does not warrant that the operation of the instrument, or software, or firmware will be uninterrupted or error free.

Limitation Of Warranty

The foregoing warranty shall not apply to defects resulting from improper or inadequate maintenance by Buyer, Buyer-supplied software or interfacing, unauthorized modification or misuse, operation outside of the environmental specifications for the product, or improper site preparation or maintenance.

No other warranty is expressed or implied. HP specifically disclaims the implied warranties of merchantability and fitness for a particular purpose.

Exclusive Remedies

The remedies provided herein are buyer's sole and exclusive remedies. HP shall not be liable for any direct, indirect, special, incidental, or consequential damages, whether based on contract, tort, or any other legal theory.

Assistance

Product maintenance agreements and other customer assistance agreements are available for Hewlett-Packard products.

For any assistance, contact your nearest Hewlett-Packard Sales and Service Office. Address are provided at the back of this manual.

Safety Symbols

General definitions of safety symbols used on equipment or in manuals.



Instruction manual symbol: the product will be marked with this symbol when it is necessary for the user to refer to the instruction manual in order to protect against damage to the instrument.



Indicates dangerous voltage (terminals fed from the interior by voltage exceeding 1000 volts must be so marked).

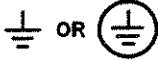

Protective conductor terminal. For protection against electrical shock in case of a fault. Used with wiring terminals to indicate the terminal which must be connected to ground before operating equipment.



Low-noise or noiseless, clean ground (earth) terminal. Used for a signal common, as well as providing protection against electrical shock in case of fault. A terminal marked with this symbol must be connected to ground in the manner described in the installation (Operation) manual, and before operating the equipment.

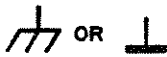

Frame or chassis terminal. A connection to the frame (chassis) of the equipment which normally includes all exposed metal structures.



Alternating current (power line).



Direct current (power line).



Alternating or direct current (power line).

Warning



Warning denotes a hazard. It calls attention to a procedure, practice, condition or the like, which, if not correctly performed or adhered to, could result in injury or death to personnel.

Caution



Caution sign denotes a hazard. It calls attention to a procedure, practice, condition or the like, which, if not correctly performed or adhered to, could result damage to or destruction of part or all of the product.

Note



Note denotes important information. It calls attention to a procedure, practice, condition or the like, which is essential to highlight.



**HP 87510A GAIN-PHASE ANALYZER
REFERENCE MANUAL**



Printed in JAPAN December 1991

GUIDE TO THE CHAPTERS IN THIS DOCUMENT

For information on specific topics, refer to the index at the end of this volume.

This section of this document is a complete reference for operation of the HP 87510A Gain-Phase Analyzer using either front panel controls, or an external controller. It is divided into chapters providing the following information:

- Chapter 1 provides getting started guide. Read this chapter first, when you get the HP 87510A.
- Chapter 2 provides the general information, which includes the product description, option and accessories available.
- Chapter 3 provides the specifications and typical characteristics of the HP 87510A.
- Chapter 4 includes a block diagram and functional description of the analyzer system. This is followed by descriptions of the front panel features and display labels, and the rear panel features and connectors.
- Chapters 5 through 14 provide detailed information on front panel keys and softkeys, their purpose and use, HP-IB equivalents in parentheses, and expected indications and results. Specific areas of operation described in these chapters include calibration procedures for accuracy enhancement, using markers, limit testing, plotting and printing, and saving instrument states.
- Chapter 15 contains information for operating the system remotely with a controller through HP-IB.
- Appendix provides a complete listing of the instrument preset state, a map of the operating softkey menu structure, information on I/O ports, and information on manual changes.
- Error Messages lists analyzer error messages, with explanations.
- Index lists an alphabetical index.

Safety Symbols

General definitions of safety symbols used on equipment or in manuals.



Instruction manual symbol: the product will be marked with this symbol when it is necessary for the user to refer to the instruction manual in order to protect against damage to the instrument.



Indicates dangerous voltage (terminals fed from the interior by voltage exceeding 1000 volts must be so marked).

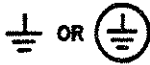

Protective conductor terminal. For protection against electrical shock in case of a fault. Used with wiring terminals to indicate the terminal which must be connected to ground before operating equipment.



Low-noise or noiseless, clean ground (earth) terminal. Used for a signal common, as well as providing protection against electrical shock in case of fault. A terminal marked with this symbol must be connected to ground before operating the equipment.

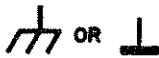

Frame or chassis terminal. A connection to the frame (chassis) of the equipment which normally includes all exposed metal structures.



Alternating current (power line).



Direct current (power line).



Alternating or direct current (power line).

Warning



Warning denotes a hazard. It calls attention to a procedure, practice, condition or the like, which, if not correctly performed or adhered to, could result in injury or death to personnel.

Caution



Caution sign denotes a hazard. It calls attention to a procedure, practice, condition or the like, which, if not correctly performed or adhered to, could result in damage to or destruction of part or all of the product.

Note



Note denotes important information. It calls attention to a procedure, practice, condition or the like, which is essential to highlight.

Contents

1. Getting Started	
Introduction	1-1
Unpacking Your Instrument	1-1
Operating Conditions	1-2
Power Considerations	1-3
Instrument Setup	1-4
Turning on the Analyzer	1-4
HARDKEYS and SOFTKEYS	1-4
Checking HP-IB Addresses	1-5
2. General Information	
About this Manual Set	2-1
Instruments Covered by This Manual	2-1
Microfiche Copies of the Manual	2-1
HP 87510A Description	2-2
Additional Features	2-2
Advanced List Sweep Mode	2-2
Automatic Sweep Time	2-2
Automatic Interpolated Error Correction	2-2
Four Trace Simultaneous Measurement	2-2
HP Instrument BASIC	2-3
I/O port	2-3
Waveform Analysis Commands	2-3
Hewlett-Packard Interface Bus (HP-IB)	2-3
Options Available	2-4
Option 001, High Stability Frequency Reference	2-4
Option 002, Keyboard for HP Instrument BASIC	2-4
Option 003, Type-N Input Connector	2-4
Option 004, Delete Reference Channel	2-4
Option 005, Parallel I/O Mode A	2-4
Option 006, Parallel I/O Mode B	2-4
Option 0B0, Delete Operation Manual	2-4
Option 907, Front Handle Kit	2-4
Option 908, Rack Mount Kit	2-4
Option 909, Rack and Handle Kit	2-5
Option 0B1, Extra Operation Manual	2-5
Option 0B3, Add Service Manual	2-5
Measurement Accessories Available	2-5
Active Probes	2-5
HP 41800A Active Probe	2-5
HP 41802A 1 M Ω Input Adapter	2-5
System Accessories Available	2-5
System Rack	2-5
Plotters and Printers	2-6
HP-IB Cables	2-6

Disks and Disk Accessories	2-6
3. Instrument Specifications	
Source	3-1
Frequency Characteristics	3-1
Output Power Characteristics	3-1
Power Splitter	3-1
Spectral Purity Characteristics	3-2
Other Source Information	3-2
Receiver	3-2
Input Characteristics	3-2
Magnitude Characteristics	3-2
Absolute Characteristics	3-2
Ratio Characteristics	3-3
Phase Characteristics	3-3
Delay Characteristics	3-4
General Characteristics	3-4
Rear Panel Specifications	3-5
I/O Buses	3-5
HP-IB Interface	3-5
I/O Port	3-5
BNC Connectors	3-5
"EXT REF INPUT 10/N MHz" Connector	3-5
"REF OVEN (OPTION 001)" Connector	3-5
"INT REF OUTPUT" Connector	3-5
"EXT TRIGGER" Connector	3-6
"EXT PROG RUN/CONT" Connector	3-6
Specifications when Option Is Installed	3-6
Specifications When Option 003 Type N Connector Is Installed	3-6
Specifications When Option 004 Delete Rch Is Installed	3-6
Furnished Accessories	3-7
4. System Overview	
System Overview	4-1
Overall Operation	4-1
The Built-In Synthesized Source	4-1
The Built-in Power Splitter	4-2
The Receiver Block	4-2
The Microprocessors	4-2
Data Processing	4-2
Overview	4-2
Important Concepts	4-2
Processing Details	4-3
The ADCs	4-3
Digital Filter	4-3
IF Correction	4-4
Ratio Calculations	4-4
Sweep-to-sweep Averaging	4-4
Vector Error Correction (Accuracy Enhancement)	4-4
The Delay Block (Electrical Delay)	4-4
Conversion Transforms	4-4
Formatting	4-4
Smoothing	4
Format Arrays	4-5
Scaling	4-5

Display Memory	4-5
5. Front and Rear Panel	
Introduction	5-1
Active Function	5-1
Front Panel Keys and Softkey Menus	5-1
Softkeys that are Joined by Vertical Lines	5-2
Softkeys That Toggle ON or OFF	5-2
Softkeys that Show Status Indications in Brackets	5-2
Function Key Blocks	5-2
Stimulus Block	5-2
Response Block	5-2
Instrument State Block	5-2
HP-IB Control	5-3
Information on Keys and Softkeys	5-3
Front Panel Features	5-3
CRT Display	5-5
Rear Panel Features and Connectors	5-8
6. Active Channel Block	
Active Channel Keys	6-1
7. Entry Block	
Entry Block Keys	7-1
8. Stimulus Function Block	
Introduction	8-1
START, STOP, CENTER, and SPAN Keys	8-1
MENU Key	8-2
Stimulus Menu	8-3
Sweep Time Menu	8-5
Trigger Menu	8-6
Sweep Type Menu	8-7
List Sweep Menu	8-8
Edit List Menu	8-9
Edit Segment Menu	8-10
Edit Segment More Menu	8-11
Clear List Menu	8-12
9. Response Function Block	
Introduction	9-1
MEAS Key	9-2
Input Ports Menu	9-2
Conversion Menu	9-3
FORMAT Key	9-5
Format Menu	9-5
Format More Menu	9-8
Group Delay Principles	9-9
SCALE REF Key	9-11
Scale Reference Menu	9-11
Electrical Delay Menu	9-13
DISPLAY Key	9-14
Display Menu	9-14
Display More Menu	9-16
Display Allocation Menu	9-17

Title Menu	9-18
AVG Key	9-19
Averaging	9-19
Smoothing	9-20
IF Bandwidth Reduction	9-20
Group Delay Aperture	9-21
Average Menu	9-21
IF Bandwidth Menu	9-23
SPCL FCTN Key	9-24
Special Function Menu	9-24
Special Function More Menu	9-26
10. Measurement Calibration	
Introduction	10-1
Accuracy Enhancement	10-1
Correcting for Measurement Errors	10-2
Menus and Softkeys	10-3
CAL Key	10-3
Interpolated Error Correction	10-3
Channel Coupling	10-4
Omitting Isolation Calibration	10-4
Stopping During the Calibration Procedure	10-4
Saving Calibration Data	10-4
Specifying Calibration Kits	10-4
Correction Menu	10-5
Select Cal Kit Menu	10-6
Calibrate More Menu	10-7
Reference Plane Menu	10-8
Calibration Menu	10-9
Response Calibration for Transmission Measurements	10-10
Response and Isolation Calibration for Transmission Measurements	10-10
Modifying Calibration Kits	10-11
Definitions	10-12
Procedure	10-12
Modify Cal Kit Menu	10-13
Define Standard Number Menu	10-15
Define Standard Menus	10-15
Specify Offset Menu	10-17
Label Standard Menu	10-18
Specify Class Menus	10-18
Label Class Menus	10-19
Label Kit Menu	10-19
Verify Performance	10-20
11. Using Markers	
MKR Key	11-1
Marker Menu	11-3
Activate marker menu	11-4
Clear Marker Menu	11-5
Delta Marker Mode Menu	11-5
Delta Marker Menu	11-6
Fixed Marker Menu	11-7
Marker Mode Menu	11-9
Polar Marker Menu	11-10
MKR FCTN Key	11-11

Marker Function Menu	11-11
Search Range Menu	11-13
Marker Search Menu	11-14
Target Menu	11-15
Marker Search More Menu	11-16
Note For Peak Define	11-16
Width Menu	11-17
12. Instrument State Function Block	
Introduction	12-1
Instrument State Functions and Where They Are Described	12-1
LOCAL Key	12-2
Local Lockout	12-3
HP-IB Menu	12-3
System Controller Mode	12-3
Addressable Mode	12-3
Address Menu	12-4
SYSTEM Key	12-6
System Menu	12-6
Instrument BASIC	12-7
BASIC Menu	12-7
Edit System Menu	12-8
ON KEY LABEL Menu	12-8
File Utility Menu	12-8
Command Entry Menu	12-9
Real Time Clock	12-9
Clock Menu	12-10
Set Time Menu	12-10
Set Date Menu	12-10
BIN Sort Function	12-11
Example of Using the BIN Sort Function	12-11
BIN Sort Softkey Menu	12-13
BIN Sort Menu	12-13
Edit BIN Sort Menu	12-14
Edit BIN Sort Table Menu	12-15
Clear Menu	12-16
Limit Line and Limit Testing	12-16
How Limit Lines are Entered	12-18
Turning Limit Lines Limit Testing On and Off	12-19
Segments Entering Order Needs Notice	12-19
Saving the Limit Line Table	12-19
Offsetting the Stimulus or Amplitude of the Limit Lines	12-19
Supported Display Formats	12-19
Use a Sufficient Number of Points or Errors May Occur	12-19
Displaying, Printing, or Plotting Limit Test Data	12-20
Results of Plotting or Printing the Display with Limit Lines ON	12-20
Limit Menu	12-20
Edit Limits Menu	12-21
Edit Segment Menu	12-22
Clear List Menu	12-24
Offset Limit Menu	12-24
Using Limit Line Testing	12-25
Example of Limit Lines for Filter Testing	12-25
Instrument Setting	12-25
Creating Limit Lines	12-26

Modifying Limit Lines Using The Rotary Knob and Marker	12-27
Performing Limit Test	12-27
Example 2. Separated Limit Lines	12-28
13. Making Hard Copies	
Introduction	13-1
About Making Hard Copies, Where Compatible Printers and Plotters are Mentioned	13-1
Where to Find Tutorial Information	13-1
Printing/Plotting with or without a Controller on the Bus	13-1
Print/Plot Buffer	13-2
COPY Key	13-2
Copy Menu	13-4
Select Quadrant Menu	13-5
Define Plot Menu	13-6
Pen Numbers	13-6
Scale Plot Menu	13-7
Copy More Menu	13-8
Copy Cal Kit Menu	13-10
Copy Standard Number Menu	13-11
Copy List Sweep Menu	13-11
Copy Limit Test Menu	13-12
Screen Menu	13-13
Using Printer and Plotter	13-14
Preparing Printers/Plotters	13-14
Available Displays To Print/Plot	13-14
Output with The Time/Date	13-14
Adding a Title	13-14
Printing Procedure	13-14
Plotting Procedure	13-15
Printing and Plotting Troubleshooting	13-15
14. Saving and Recalling Instrument States and Data	
Introduction	14-1
Storage Devices	14-1
File Types and Data Saved	14-2
Binary Files and ASCII Files	14-2
Data Groups	14-2
Instrument States	14-2
Internal Data Arrays	14-2
Instrument States and Internal Data Arrays	14-3
Internal Data Arrays (ASCII file)	14-3
Graphics	14-3
Additional Information	14-3
RAM Disk Memory Capacity	14-3
Operating Time of the Battery Backup for RAM Disk Memory	14-3
Disk Requirements	14-4
Disk Formats	14-4
File Names	14-4
Copy Files Between the RAM Disk and the Flexible Disk	14-5
Auto Recall Function	14-5
File Size	14-5
File Structure of Internal Data Arrays File for Binary Files	14-6
File Header	14-6
Data Group	14-6

Data Segment	14-7
File Structure of Internal Data Arrays File for ASCII File	14-8
Status Block and Data Block	14-8
File Structure for Single Channel and Dual Channel	14-10
Data Array Names	14-10
Data Groups	14-11
SAVE and RECALL Keys	14-11
Save Menu	14-13
Title Menu	14-14
ASCII Save Menu	14-15
Define Extension Menu	14-16
Define Save Data Menu	14-17
Re-save File Menu	14-18
Disk Menu	14-19
Purge File Menu	14-20
Purge Menu	14-21
Initialize Menu	14-21
Recall File Menu	14-22
Copy Menu	14-23
Destination Menu	14-24
15. HP-IB Remote Programming	
Introduction	15-1
How HP-IB Works	15-1
Talker	15-2
Listener	15-2
Controller	15-2
HP-IB Requirements	15-2
Analyzer HP-IB Capabilities	15-3
Bus Mode	15-3
Setting Addresses	15-4
A. Manual Changes	
Introduction	A-1
Manual Changes	A-1
B. Default	
Preset State	B-1
Predefined Calibration Kit	B-6
Predefined Standards	B-6
Predefined Standard Class Assignments	B-8
C. Parallel I/O (STANDARD and OPTION 006)	
I/O Ports	C-1
Control Signal Lines	C-2
Port C Status Output Signal or Port D Status Output Signal	C-2
WRITE STROBE Output Signal for Output Port	C-2
INPUT1 Input Signal	C-2
OUTPUT1 Output Signal or OUTPUT2 Output Signal	C-3
PASS/FAIL Output Signal	C-3
WRITE STROBE Output Signal for PASS/FAIL Output	C-3
SWEEP END Output Signal	C-3
Pin Assignment	C-4
HP-IB Commands for Parallel I/O Port Control	C-7
Data Output Commands	C-7

Data Input Commands	C-7
Commands for Setting Input/Output Directions of Ports C and D	C-7
Positive and Negative Logic Setting Commands	C-7
OUTPUT1 and OUTPUT2 Level Setting Commands	C-8
Commands for Setting OUTPUT1 and OUTPUT2 at the High or Low Level upon input of a Pulse to INPUT1	C-8
Command for Checking Input to INPUT1	C-8
D. Option 005 Parallel I/O Mode A (8-bit)	
I/O Port	D-1
Pin Assignment	D-1
Related HP-IB Commands	D-2
E. Softkey Tree	
STIMULUS Block	E-1
RESPONSE Block	E-2
INSTRUMENT STATE FUNCTION Block	E-8
Messages	
Error Messages in Alphabetical Order	Messages-1
Error Messages in Numerical Order	Messages-12
Index	

Figures

1-1. HP 87510A and Furnished Accessories	1-2
1-2. Voltage Selector	1-3
1-3. Connecting BNC adapter (Option 001 Only)	1-4
2-1. Typical Serial Number Plate	2-1
3-1. Trigger Signal	3-6
3-2. Power Cables Supplied	3-8
4-1. Simplified Block Diagram of the Network Analyzer System	4-1
4-2. Data Processing Flow Diagram	4-3
5-1. HP 87510A Front Panel	5-3
5-2. CRT Display (Single Channel, Cartesian Format)	5-5
5-3. HP 87510A Rear Panel	5-8
6-1. Active Channel Keys	6-1
7-1. Entry Block	7-1
8-1. Stimulus Function Block	8-1
8-2. Softkey Menus Accessed from the (MENU) Key	8-2
8-3. Stimulus Menu	8-3
8-4. Sweep Time Menu	8-5
8-5. Trigger Menu	8-6
8-6. Sweep Type Menu	8-7
8-7. List Sweep Menu	8-8
8-8. Edit List Menu	8-9
8-9. Edit Segment Menu	8-10
8-10. Edit Segment More Menu	8-11
8-11. Clear List Menu	8-12
9-1. Response Function Block	9-1
9-2. Softkey Menus Accessed from the (MEAS) Key	9-2
9-3. Input Ports Menu	9-3
9-4. Transmission Impedance and Admittance Conversions	9-3
9-5. Conversion Menu	9-4
9-6. Format and Format More Menus	9-5
9-7. Log Magnitude Format	9-5
9-8. Phase Format	9-6
9-9. Group Delay Format	9-6
9-10. Linear Magnitude Format	9-7
9-11. Expanded phase Format	9-7
9-12. Log Magnitude and Phase Format	9-7
9-13. Log magnitude and Delay Format	9-8
9-14. Real Format	9-8
9-15. Polar Format	9-9
9-16. Constant Group Delay	9-9
9-17. Higher Order Phase Shift	9-10
9-18. Rate of Phase Change Versus Frequency	9-10
9-19. Variations in Frequency Aperture	9-10
9-20. Softkey Menus Accessed from the (SCALE REF) Key	9-11
9-21. Scale Reference Menu	9-12
9-22. Electrical Delay Menu	9-13

9-23. Softkey Menus Accessed from the DISPLAY Key	9-14
9-24. Display Menu	9-14
9-25. Full-screen and Split Display	9-15
9-26. Display More Menu	9-16
9-27. Display Allocation Menu	9-17
9-28. Title Menu	9-18
9-29. Softkey Menus Accessed from the AVG Key	9-19
9-30. Effect of Averaging on a Trace	9-19
9-31. Effect of Smoothing on a Trace	9-20
9-32. IF Bandwidth Reduction	9-21
9-33. Average Menu	9-21
9-34. IF Bandwidth Menu	9-23
9-35. Softkey Menus Accessed from the SPCL FCTN Key	9-24
9-36. Special Function Menu	9-24
9-37. Output Filter Parameters Example	9-25
9-38. Four-Element Equivalent Circuit for Crystal Resonator	9-26
9-39. Special Function More Menu	9-26
10-1. Softkey Menus Accessed from the CAL Key	10-3
10-2. Correction Menu	10-5
10-3. Select Cal Kit Menu	10-6
10-4. Calibrate More Menu	10-7
10-5. Reference Plane Menu	10-8
10-6. Calibration Menu	10-9
10-7. Response Cal Menu	10-10
10-8. Modify Cal Kit Menus	10-13
10-9. Modify Cal Kit Menu	10-14
10-10. Define Standard Number Menu	10-15
10-11. Specify Offset Menu	10-17
11-1. Menus Accessed from the MKR Key	11-2
11-2. Marker Menu	11-3
11-3. Activate Marker Menu	11-4
11-4. Clear Marker Menu	11-5
11-5. Delta Marker Mode Menu	11-6
11-6. Delta Marker Menu	11-7
11-7. Fixed Marker Menu	11-8
11-8. Marker Mode Menu	11-9
11-9. Polar Marker Menu	11-10
11-10. Menus Accessed from the MKR FCTN Key	11-11
11-11. Marker Function Menu	11-12
11-12. Search Range Menu	11-13
11-13. Marker Search Menu	11-14
11-14. Target Menu	11-15
11-15. Marker Search More Menu	11-16
11-16. Peak Definition Example	11-17
11-17. Width Menu	11-17
11-18. Bandwidth Search Example	11-18
12-1. Instrument State Function Block	12-1
12-2. Softkey Menus Accessed from the LOCAL Key	12-2
12-3. HP-IB Menu	12-3
12-4. Address Menu	12-5
12-5. System Menu	12-6
12-6. Softkey Menus Accessed from the IBASIC Softkey	12-7
12-7. Softkey Menus Accessed from the SET CLOCK Softkey	12-9
12-8. Example of Sorting by Deviation	12-12

12-9. A Complex Example	12-12
12-10. Softkey Menu Accessed from the BIN SORT MENU Softkey	12-13
12-11. BIN Sort Menu	12-13
12-12. Edit BIN Sort Menu	12-14
12-13. Edit BIN Sort Table Menu	12-15
12-14. Clear Menu	12-16
12-15. Softkey Menus Access from the LIMIT MENU softkey.	12-17
12-16. The Concept of Segments as a Point between Two Sets of Limit Lines	12-18
12-17. Limits Menu	12-20
12-18. Edit Limits Menu	12-22
12-19. Edit Segment Menu	12-23
12-20. Clear List Menu	12-24
12-21. Offset Limit Menu	12-24
12-22. Limit Line Example	12-25
12-23. Editing the Limit Lines	12-27
12-24. Limit Lines Example 2 (Separated Limit Lines)	12-28
13-1. Softkey Menus Accessed from the COPY Key	13-3
13-2. Copy Menu	13-4
13-3. Select Quadrant Menu	13-5
13-4. Define Plot Menu	13-6
13-5. Scale Plot Menu	13-7
13-6. Full, Upper, and Lower Graticule	13-8
13-7. Copy More Menu	13-8
13-8. Copy Cal Kit Menu	13-10
13-9. Copy Standard Number Menu	13-11
13-10. Copy List Sweep Menu	13-11
13-11. Copy Limit Test Menu	13-12
13-12. Screen Menu	13-13
14-1. File Header Structure	14-6
14-2. CAL Data Group Structure	14-7
14-3. Data Segment	14-7
14-4. Softkey Menus Accessed from the SAVE and RECALL Keys	14-12
14-5. Save Menu	14-13
14-6. Title Menu	14-14
14-7. ASCII Save Menu	14-15
14-8. Define Extension Menu	14-16
14-9. Define Save Data Menu	14-17
14-10. Re-save File Menu	14-18
14-11. Disk Menu	14-19
14-12. Purge File Menu	14-20
14-13. Purge Menu	14-21
14-14. Initialize Menu	14-21
14-15. Recall File Menu	14-22
14-16. Copy Menu	14-23
14-17. Destination Menu	14-24
15-1. Analyzer Single Bus Concept	15-3
C-1. Write strobe signal timing chart	C-2
C-2. Schematic Drawing of Parallel I/O Ports	C-4
C-3. Parallel I/O Port Connector Pin Numbers	C-4
D-1. 8-bit I/O Port Pin Assignments	D-1
E-1. MENU key	E-1
E-2. MEAS Key	E-2
E-3. FORMAT Key	E-2
E-4. SCALE REF Key	E-3
E-5. DISPLAY Key	E-3

E-6.	AVG Key	E-3
E-7.	CAL Key (1/2)	E-4
E-8.	CAL Key (2/2)	E-5
E-9.	MKR Key	E-6
E-10.	MKR FCTN Key	E-7
E-11.	SPCL FCTN Key	E-7
E-12.	LOCAL Key	E-8
E-13.	SYSTEM Key (1/4)	E-8
E-14.	SYSTEM Key (2/4)	E-9
E-15.	SYSTEM Key (3/4)	E-9
E-16.	SYSTEM Key (4/4)	E-10
E-17.	COPY Key	E-11
E-18.	SAVE and RECALL Key	E-12

Tables

1-1. AC Line Voltage	1-3
1-2. Factory-set Addresses	1-5
2-1. Disks and Disk Accessories	2-6
8-1. Minimum Sweep Time In Seconds (Typical Value)	8-6
9-1. IF Bandwidth in AUTO mode	9-23
10-1. Differences between <u>PORT EXTENSIONS</u> and <u>ELECTRICAL DELAY</u>	10-7
10-2. Standard Definitions	10-16
10-3. Standard Class Assignments Table	10-18
12-1. Instrument State Function Descriptions	12-2
12-2. Default HP-IB Addresses	12-4
13-1. Default Plotting Parameters	13-5
13-2. Pen Numbers	13-6
13-3. List Value Format	13-9
14-1. Valid Characters for File Names	14-4
14-2. Suffixes and Extensions Added Automatically	14-4
14-3. File Size Versus Number of Points (binary files)	14-5
14-4. File Size Versus Number of Points (ASCII files) 1/2	14-5
14-5. File Size Versus Number of Points (ASCII files) 2/2	14-6
14-6. Contents of ASCII Files	14-9
14-7. Data Groups and Data Array Names	14-10
14-8. Calibration Type Versus CAL Data Saved	14-11
A-1. Manual Changes by Serial Number	A-1
A-2. Manual Changes by Firmware Version	A-1
B-1. Preset Conditions	B-1
B-2. Preset conditions	B-2
B-3. Preset conditions	B-3
B-4. Preset conditions	B-4
B-5. Preset conditions	B-5
B-6. Preset Conditions	B-5
B-7. Results of Power Loss to Battery Backup Memory (Factory Setting)	B-6
B-8. 7 mm Standard Cal Kit	B-6
B-9. 50 Ω Type-N Standard Cal Kit	B-7
B-10. 75 Ω Type-N Standard Cal Kit	B-7
B-11. Standard Class Assignments Table (7 mm)	B-8
B-12. Standard Class Assignments Table (50 Ω Type-N)	B-8
B-13. Standard Class Assignments Table (75 Ω Type-N)	B-9
C-1. Assignment of Signals to Pins (Standard)	C-5
C-2. Assignment of Signals to Pins (Option 006)	C-6



Getting Started

Introduction

This chapter describes how to set up the HP 87510A. Read this chapter when you first get the HP 87510A. The main topics of this chapter are:

- Unpacking Your Instrument
- Operating Conditions
- Power Considerations
- Instrument Setup
- Turning on the Analyzer
- Checking the HP-IB Address

Unpacking Your Instrument

This instrument has been carefully inspected both electrically and mechanically before being shipped from the factory. It should be in perfect physical condition, no scratches, dents, or the like, and it should be in perfect electrical condition. Verify this by carefully performing an incoming inspection to check the instrument for signs of physical damage, missing contents, and to check that it passes the electrical performance test. If any discrepancy is found, notify the carrier and Hewlett-Packard. Your HP Sales Office will arrange for repair and replacement without waiting for the claim to be settled.

1. Inspect the shipping container for damage, and keep the shipping materials until the inspection is completed.
2. Verify that the shipping container contains everything shown in Figure 1-1.
3. Make sure the serial number on the analyzer's rear panel matches that on the shipping documents.
4. Inspect the exterior of the HP 87510A for any signs of damage.
5. Verify that the HP 87510A is equipped with the options you ordered.
6. To verify the HP 87510A's electrical performance, perform the Performance Test, described in the *HP 87510A Maintenance Manual* (HP part number 87510-90030).

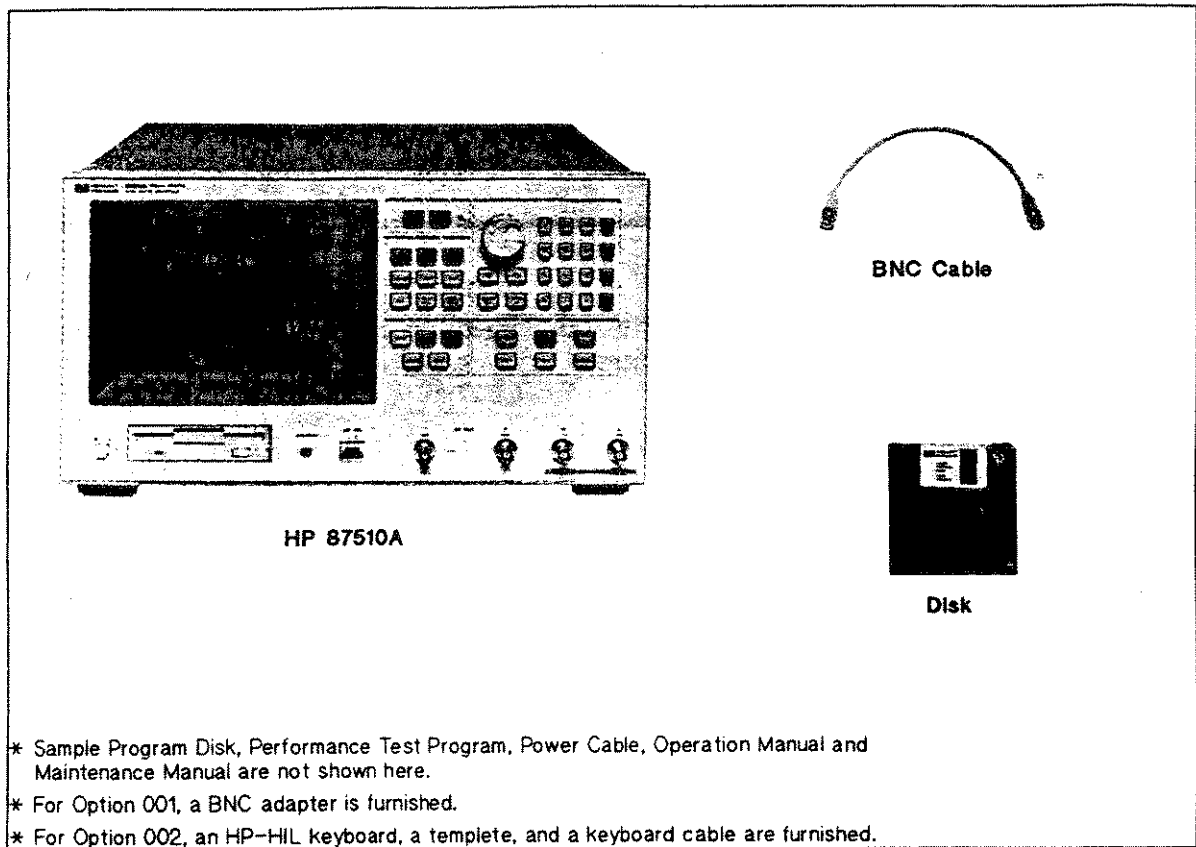

Figure 1-1. HP 87510A and Furnished Accessories

Caution



Electrostatic discharge (ESD) can damage the analyzer and other sensitive electronic devices. Use static-safe work stations and procedures.

Operating Conditions

The analyzer will operate within a wide range of temperatures, altitudes, and levels of humidity. The operating conditions are as follows:

- Temperature : 0 to 55 °C (When disk drive is not in operation)
- Humidity (at wet bulb ≤ 29 °C, without condensation) :
15% \leq RH \leq 95% (When disk drive is not in operation)
- Altitude : 0 to 4,500 meters (15,000 feet)

See Chapter 3 for more details. Note that enhanced accuracy performance and some instrument specifications require an environmental temperature of 23 ± 5 °C.

Power Considerations

Warning



This is a safety class 1 product (provided with a protective earth terminal). A noninterruptable safety earth ground must be provided from the main power source to the HP 87510A's power input terminals, power cord, or supplied power cord set. Whenever the safety earth ground has been impaired, the instrument must be made inoperative and secured against any unintended operation. If this instrument is to be energized via an autotransformer (Not Recommended) for voltage reduction, make sure that the common terminal is connected to the earth pole of the power source.

Confirm that the analyzer voltage selector (shown in Figure 1-2) is set to match the AC line voltage before plugging in the analyzer.

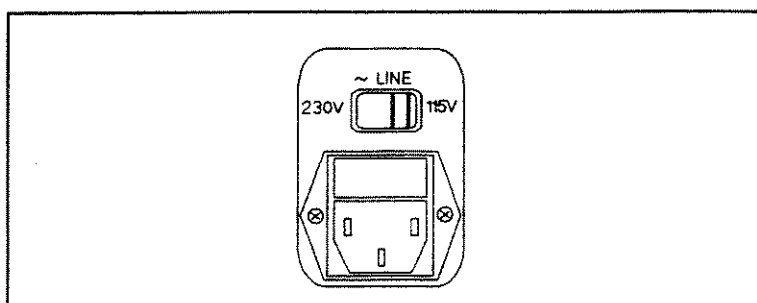

Figure 1-2. Voltage Selector

Table 1-1. AC Line Voltage

Nominal Setting	AC Line Power
115 V	90 V to 132 V (at 47 to 66 Hz)
230 V	198 V to 264 V (at 47 to 66 Hz)

For information on line fuse replacement, see Chapter 1 of the *Maintenance Manual*.

To protect operating personnel, the National Electrical Manufacturer's Association (NEMA) recommends that the instrument panel and cabinet be grounded. The HP 87510A is equipped with a three-conductor power cord that, when plugged into the appropriate AC power receptacle, grounds the instrument. The offset pin on the power cord is the safety ground.

To preserve the protection feature when operating the instrument from a two prong outlet, use a three-prong to two-prong adapter (HP Part Number 1251-8196) and connect the green pigtail on the adapter to the protective earth connection.

Caution



The power plug must be plugged into an outlet that provides a protective earth connection. DO NOT use an extension cord or power cord that does not have a protective ground.

Instrument Setup

This section describes HP 87510A system setups.

Note



For an HP 87510A with Option 001, connect the EXT REF INPUT connector to the REF OVEN connector on the rear panel using the furnished BNC adapter. (See Figure 1-3.)

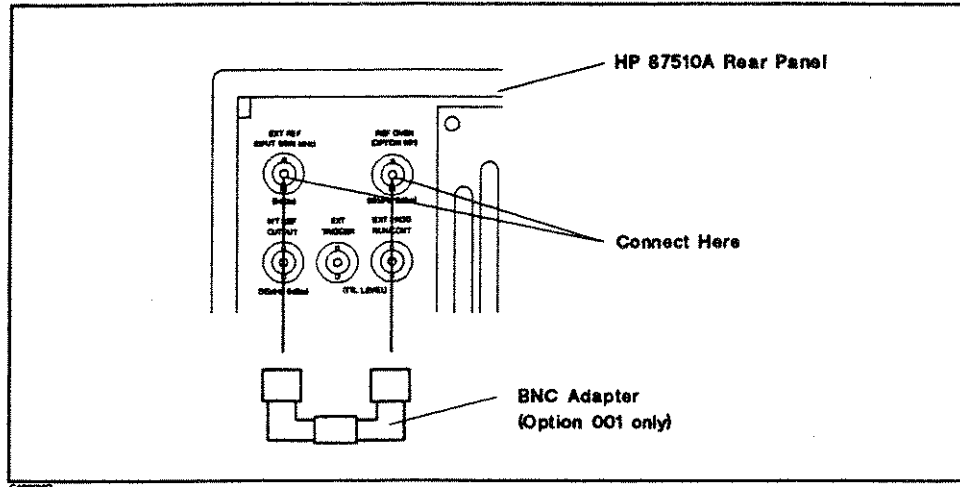

Figure 1-3. Connecting BNC adapter (Option 001 Only)

Turning on the Analyzer

Turn the line switch ON. The analyzer should power up with no error messages displayed, in which case, the analyzer has passed its internal diagnostic tests and is functioning properly.

Note



If an error message is displayed, or if the instrument does not appear to operate properly, see "Error Messages" in this manual.

HARDKEYS and **SOFTKEYS**

In this guide, front panel keys (hard keys) are represented by print surrounded by a box, **xxx**. Display softkeys are shown as print on a half-tone background, **xxx**.

For example: "Press **SCALE REF** **REFERENCE POSITION** -10 **x1**" means you should press the **SCALE REF** key, then the **REFERENCE POSITION** softkey, followed by the **-**, **1**, **0** and **x1** keys. The last key, **x1**, terminates the command in basic units (dB, dBm, Hz, or degrees). More explanation of display keys is found in after Chapter 5.

Checking HP-IB Addresses

For hard copy output, an HP-IB cable must connect the analyzer to an HP-IB equipped printer or plotter.

To communicate by HP-IB, two conditions must be satisfied:

- Each device must have a unique address.
- The analyzer must recognize each address.

To check each device's HP-IB address, see its manual (most addresses are set with switches). To check the analyzer's address, press **LOCAL** **SET ADDRESSES** **ADDRESS : 87510**. The analyzer's address will appear.

Table 1-2 shows the factory-set device addresses which are also the default addresses recognized by the analyzer.

Table 1-2. Factory-set Addresses

Device	HP-IB Address
HP 87510A	17
Printer	1
Plotter	5
External Controller (computer)	21

To change an HP-IB address (recognized by the analyzer) to match a device address, press the device softkey and then enter the address and **(x1)**.



General Information

About this Manual Set

This *HP 87510A Gain-Phase Analyzer Operation Manual* is a complete guide to operating the analyzer. It is part of a two manual set; the *Maintenance Manual* completes the set.

To explore the manuals further, inspect their title pages and the "Contents" and "Index" sections.

Instruments Covered by This Manual

The instrument you received with this manual is covered by this manual without change. Any other instrument with one of the serial number prefixes listed on the title page is also described by this manual. (The serial number plate, shown in Figure 2-1, is attached to the rear panel of the analyzer.)

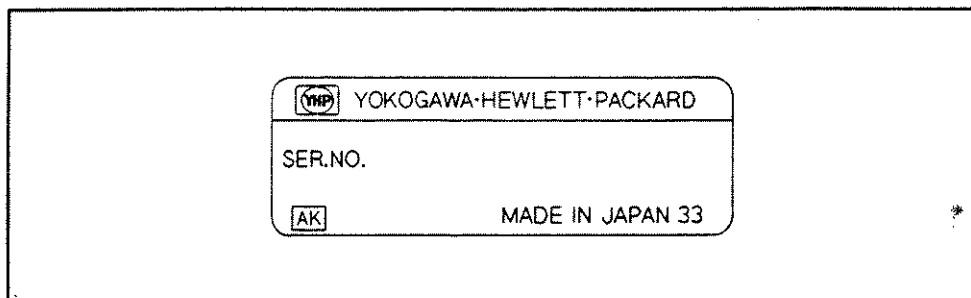

Figure 2-1. Typical Serial Number Plate

Other instruments differ from the instruments covered directly by this manual. Those differences are documented in the Appendix A section. See Appendix A section if the serial number prefix of your instrument is not listed on the title page.

Microfiche Copies of the Manual

Use the microfiche part number on the title page to order a package of 10 × 15 centimeter (4 × 6 inch) microfilm transparencies of this manual and the *Maintenance manual*.

HP 87510A Description

The HP 87510A is a 100 kHz to 300 MHz Gain-phase analyzer for measuring transmission parameters. It integrates a high resolution synthesized RF source, and a dual channel, two-input receiver to measure and display magnitude, phase, and group delay responses of active and passive RF networks. Option 001 provides a high stability frequency reference, and Option 002 provides HP Instrument BASIC programmability. For information on other options, see "Options Available" later in this section.

Two independent display channels and a large screen CRT display the measurement results of one or both channels, in rectangular or polar chart formats. The display function has the capability to display three traces simultaneously.

Digital signal processing and microprocessor control combine to provide easy operation and measurement improvement. Measurement functions are selected with front panel keys and softkey menus. Displayed measurement results can be printed or plotted directly with a compatible peripheral without the use of an external computer. A built-in micro flexible disk drive and RAM disk memory store and recall instrument states and trace data (measurement data).

Trace math, data averaging, trace smoothing, electrical delay, and accuracy enhancement provide performance improvement and flexibility. Accuracy enhancement methods range from normalizing data to 3 term vector error correction.

Additional Features

In addition to the above capabilities, this analyzer has several features:

Advanced List Sweep Mode

The analyzer can measure specifically at user defined frequencies, power levels, IF bandwidths, and number of points as defined in the List Segment. The list sweep mode can make the display resolution even, even though the frequency points are not evenly distributed, as well as making the frequency base display even.

Automatic Sweep Time

The analyzer can automatically shorten sweep time as much as possible for the given IF bandwidth, number of points, averaging mode, frequency range, and sweep type.

Automatic Interpolated Error Correction

This allows the operator to perform any type of calibration, and then display any subset of that frequency range or use a different number of points. If the operator changes the stimulus parameter, the analyzer turns the interpolated error correction ON, and new error coefficients are interpolated from the coefficients of the original calibration. Interpolated error correction provides a great improvement over uncorrected measurements, but the accuracy of interpolated error corrected points is not specified. See Chapter 10.

Four Trace Simultaneous Measurement

The analyzer can measure and display two traces for one channel, which allows four trace simultaneous display using the dual channel display capability. In addition, stimulus values (frequency, power) can range independently for each channel.

HP Instrument BASIC

This allows analyzer programmability without any external controller. HP Instrument BASIC is a subset of HP BASIC and allows all of the analyzer's measurement capabilities and any other HP-IB compatible instrument to be programmed. Option 002 HP Instrument BASIC keyboard is required to develop programs. For more information on HP Instrument BASIC, see *Using HP Instrument BASIC with the HP 87510A* furnished with the analyzer and *HP Instrument Users Handbook* furnished with Option 002.

I/O port

This allows the creation of a production line measurement system when used with an automatic handler. See Appendix C and Appendix D for more information.

Waveform Analysis Commands

The waveform analysis function provides filter and resonator specific measurement commands. These commands can be used to analyze filter ripple, obtain filter parameters (for example 3 dB bandwidth), or to search for a resonator's series-resonant mode frequency and its parallel-resonant mode (antiresonant) frequency and to derive parameters of the equivalent circuit of resonators. Executing a command derives parameters from measurement results and returns the derived parameters by HP-IB. An external controller or HP Instrument BASIC is required to use this command set. For more information on these commands, see *HP-IB Programming Manual*. Some of these commands can be executed from the front panel using **SPCL FNCT** key. For more information on **SPCL FNCT** key, see "**SPCL FCTN** Key" in Chapter 9.

Hewlett-Packard Interface Bus (HP-IB)

The analyzer is factory-equipped with a remote programming interface using the Hewlett-Packard Interface Bus (HP-IB). HP-IB is Hewlett-Packard's hardware, software, documentation, and support for IEEE-488.1, IEEE-488.2, IEC-625, and JIS-C1901 worldwide standards for interfacing instruments. This provides a remote operator with the same control of the instrument available to the local operator, except for control of the power line switch and some internal tests. Remote control is maintained by a controlling computer that sends commands or instructions to and receives data from the analyzer using HP-IB. Several output modes are available for output data. A complete general description of HP-IB is available in *Condensed description of the Hewlett-Packard Interface Bus* (HP part number 59401-90030), and in *the Tutorial Description of the Hewlett-Packard Interface Bus* (HP literature number 5952-0156).

The analyzer itself can use the HP-IB system to produce measurement results directly to a compatible printer or plotter without using an external computer.

Options Available

Option 001, High Stability Frequency Reference

This option, a 10 MHz crystal oscillator in a temperature stabilized oven, improves the source signal frequency accuracy and stability.

Option 002, Keyboard for HP Instrument BASIC

This option adds HP-HIL keyboard and cable for editing HP Instrument BASIC program on the HP 87510A display.

See the previous section for information.

Option 003, Type-N Input Connector

This option changes A channel input to type-N connector and provides probe power output for use with active probe and high input impedance adapter.

Option 004, Delete Reference Channel

This option deletes reference channel (R ch) input and one of two power splitter output.

Option 005, Parallel I/O Mode A

This option provides 8-bit output, 4-bit input parallel I/O with 15-pin HP 8751A compatible connector on the rear panel instead of standard parallel I/O (24-bit I/O). This option cannot be installed with option 006.

Option 006, Parallel I/O Mode B

This option provides 24-bit output, 8-bit input parallel I/O with 36-pin connector on the rear panel instead of standard 24-bit I/O. This option can not be installed with option 005.

Option 0B0, Delete Operation Manual

Option 907, Front Handle Kit

Option 908, Rack Mount Kit

This option is a rack mount kit containing a pair of flanges and the necessary hardware to mount the instrument, with handles detached, in an equipment rack with 482.6 mm (19 inches) horizontal spacing.

Option 909, Rack and Handle Kit

This option is a rack mount kit containing a pair of flanges and the necessary hardware to mount the instrument with handles attached in an equipment rack with 482.6 mm (19 inches) horizontal spacing.)

Option 0B1, Extra Operation Manual

This option is an extra manual set containing the same manual set which is furnished with the analyzer.

Option 0B3, Add Service Manual

This option adds Service Manual (HP Part Number: 87510-90031).

Measurement Accessories Available

Active Probes

HP 41800A Active Probe

This is a high input impedance probe for in-circuit measurement which covers the same frequency range as the HP 87510A. Option 003 on the HP 87510A is required to use this probe.

HP 41802A 1 M Ω Input Adapter

This adapter allows use of a high impedance probe. It has a frequency range of 100 kHz to 100 MHz. Option 003 on the HP 87510A is required to use this adapter.

System Accessories Available

System Rack

The HP 85043B system rack is a 124 cm (49 inch) high metal cabinet designed to rack mount the analyzer in a system configuration. The rack is equipped with a large built-in work surface, a drawer for calibration kits and other hardware, a bookshelf for system manuals, and a locking rear door for secured access. Lightweight steel instrument support rails support the instrument along their entire depth. Heavy-duty casters make the cabinet easily movable even with the instruments in place. Screw-down lock feet permit leveling and semi-permanent installation: the cabinet is extremely stable when the lock feet are down. Power is supplied to the cabinet through a heavy-duty grounded primary power cable, and to the individual instruments through special power cables included with the cabinet.

Plotters and Printers

The HP 87510A is capable of plotting displayed measurement results directly to a compatible peripheral without the use of an external computer. The compatible plotters are:

- HP 7440A Option 002 ColorPro Eight-Pen color graphics plotter, plots on ISO A4 or 8 1/2 × 11 inch charts.
- HP 7475A Option 002 six-pen graphics plotter, plots on ISO A4, A3 or 8 1/2 × 11 inch or 11 × 17 inch charts.
- HP 7550B Option 005 high-speed eight-pen graphics plotter, plots on ISO A4, A3 or 8 1/2 × 11 inch or 11 × 17 inch charts.

The compatible printers for both printing and plotting are:

- HP 3630A Paintjet Option 002 color printer
- HP 2225A (HP-IB compatible) ThinkJet printer
- HP 2227B QuietJet printer

HP-IB Cables

An HP-IB cable is required for interfacing the analyzer with a plotter, printer, computer, or other external instruments. The cables available are HP 10833A (1 m), HP 10833B (2 m), and HP 10833D (0.5 m).

Disks and Disk Accessories

Hewlett-Packard disks are listed below.

Table 2-1. Disks and Disk Accessories

HP Parts Number	Description
92192A	Box of 10 3.5 inch, 720K byte microfloppy disks
92192N	Box of 100 3.5 inch, 720K byte microfloppy disks
92192X	Box of 10 3.5 inch, 1.44M byte microfloppy disks

Instrument Specifications

These specifications are the performance standards or limits against which the instrument is tested. When shipped from the factory, the HP 87510A meets the specifications listed in this section. The specification test procedures are covered in the *HP 87510A Maintenance Manual*.

Note  Applicable frequency range of all specifications is from 100 kHz to 300 MHz, except for the applicable frequency range is noted.

Source

Frequency Characteristics

Range	100 kHz to 300 MHz
Accuracy	
at $23 \pm 5^\circ\text{C}$	± 20 ppm
at 0 to 55°C (with Opt. 001, 20 minutes after power on)	± 1 ppm
Stability (at $23 \pm 5^\circ\text{C}$)	
.....	$\pm 5 \times 10^{-6}$ /day (Typ.)
Opt. 001, 48 hours after power on	$\pm 2.5 \times 10^{-9}$ /8 hours (Typ.)
Resolution	1 mHz (Typ.)

Output Power Characteristics

Range	-15 to +5 dBm (Typ.)
Resolution	0.2 dB (Typ.)
Level Accuracy (at $23 \pm 5^\circ\text{C}$, 0 dBm output level, 50 MHz)	± 1 dB
Flatness (at $23 \pm 5^\circ\text{C}$, relative to 0 dBm output level at 50 MHz)	+2 dB, -4 dB
Linearity (at $23 \pm 5^\circ\text{C}$, relative to 0 dBm output level at 50 MHz)	± 1 dB

Power Splitter

Insertion Loss	
Nominal	6 dB
Output Tracking	
100 kHz \leq Freq. \leq 100 MHz	0.1 dB (Typ.)
100 MHz $<$ Freq. \leq 300 MHz	0.2 dB (Typ.)
Equivalent Output SWR	
100 kHz \leq Freq. \leq 100 MHz	≤ 1.2 (Typ.)
100 MHz $<$ Freq. \leq 300 MHz	≤ 1.4 (Typ.)

© 1995 Hewlett-Packard Company

Spectral Purity Characteristics

Harmonics (at -10 dBm output level)	< -35 dBc
Non-harmonic Spurious Signals (at 0 dBm output level, ≤ 300 MHz)	< -45 dBc
Phase Noise (at 10 kHz offset from 0 dBm fundamental)	< -75 dBc/Hz

Other Source Information

Reverse Power Protection	20 dBm, 50 Vdc (Typ.)
Output Connector	BNC female, 50 Ω (nominal), two channels

Receiver

Input Characteristics

Frequency Range	100 kHz to 300 MHz (Typ.)
Impedance	
Nominal	50 Ω
Return Loss	
100 kHz \leq Freq. < 100 MHz	> 20 dB
100 MHz \leq Freq. \leq 300 MHz	> 15 dB
Maximum Input Level	0 dBm (Typ.)
Damage Level	
DC	50 Vdc
AC	20 dBm
Noise Level (at 23 \pm 5 $^{\circ}$ C, Sweep Time mode is AUTO)	
IF BW 8 kHz	-70 dBm
IF BW 4 kHz	-85 dBm
IF BW 1 kHz	-90 dBm
IF BW 200 Hz	-100 dBm
IF BW 20 Hz	-110 dBm
IF Bandwidth (IF BW)	20 Hz, 200 Hz, 1 kHz, 4 kHz, and 8 kHz (Typ.)
Input Crosstalk (0 dBm input level).....	< -100 dB
Source Crosstalk (at +5 dBm output level)	< -110 dB(Typ.)
Residual Response (except for the following points)	< -90 dBm
170.14125 MHz, 170.9275 MHz, 227.379166667 MHz, and 228.4275 MHz	
Input Connector	BNC female, 50 Ω (nominal), two inputs (R and A)
Measurement Mode	A/R, A, R (Typ.)

Magnitude Characteristics

Absolute Characteristics

Display Range (Ref. value can be set to).....	± 500 dBm (Typ.)
Display Resolution (/div can be set to).....	0.001 dB/div to 500 dB/div (Typ.)
Marker Resolution	0.001 dB or 5 digits (Typ.)
Absolute Amplitude Accuracy (at 23 \pm 5 $^{\circ}$ C and -10 dBm input level)	± 1 dB

Ratio Characteristics

Display Range (Ref. value can be set to).....	±500 dB (Typ.)
Display Resolution (/div can be set to).....	0.001 dB/div to 500 dB/div (Typ.)
Marker Resolution	0.001 dB or 5 digits (Typ.)
Frequency Response (at 23 ± 5°C, -10 dBm input level)	
100 kHz ≤ Freq. ≤ 100 MHz	±0.5 dB
100 MHz < Freq. ≤ 300 MHz	±1.0 dB

Note Frequency response can be corrected by calibration.



Dynamic Accuracy (at 23 ± 5°C, 20 Hz IF BW, -10 dBm Rch input level, relative to -20 dBm Ach input level)

0 dBm ≥ Ach Input Level > -10 dBm	±0.4 dB
-10 dBm ≥ Ach Input Level > -20 dBm	±0.08 dB
-20 dBm ≥ Ach Input Level ≥ -50 dBm	±0.05 dB
-50 dBm > Ach Input Level ≥ -60 dBm	±0.06 dB
-60 dBm > Ach Input Level ≥ -70 dBm	±0.1 dB
-70 dBm > Ach Input Level ≥ -80 dBm	±0.3 dB
-80 dBm > Ach Input Level ≥ -90 dBm	±0.9 dB
-90 dBm > Ach Input Level ≥ -100 dBm	±3 dB
Trace Noise (at 1 kHz IF BW, -10 dBm input level)	< 10 mdB rms
Stability	0.02 dB/°C (Typ.)

Phase Characteristics

Measurement Mode	Normal/Expanded
Measurement Range	
Normal mode	±100 kdeg (no radian unit available)
Expanded mode	±5 Mdeg (no radian unit available)
Display Resolution	
Normal mode	0.01 deg/div to 500 deg/div
Expanded mode	10 pdeg/div to 10 kdeg/div
Marker Resolution	
Normal mode	0.01 deg.
Expanded mode	5 digits
Frequency Response (at 23 ± 5°C, deviation from linear phase, -10 dBm input level)	
100 kHz ≤ Freq. ≤ 100 MHz	±2.5 degree
100 MHz < Freq. ≤ 300 MHz	±5.0 degree

Note This specification is only for the deviation from linear phase. Frequency response can be corrected by calibration.



Dynamic Accuracy (at 23 ± 5°C, 20 Hz IF BW, -10 dBm Rch input level, relative to -20 dBm Ach input level)

0 dBm ≥ Ach input level > -10 dBm	±3 degree
-10 dBm ≥ Ach input level > -20 dBm	±0.5 degree
-20 dBm ≥ Ach input level ≥ -60 dBm	±0.3 degree
-60 dBm > Ach input level ≥ -70 dBm	±0.6 degree
-70 dBm > Ach input level ≥ -80 dBm	±1.8 degree
-80 dBm > Ach input level ≥ -90 dBm	±6 degree

-90 dBm > Ach input level \geq -100 dBm ± 18 degree
 Trace Noise (at 1 kHz IF BW, -10 dBm input level) < 50 mdeg rms
 Stability 0.05 deg/ $^{\circ}$ C (Typ.)

Delay Characteristics

Aperture Frequency $\frac{200}{N-1}$ % to 100% of span, where N is Number of Points (Typ.)
 Display Range (Ref. value can be set to) ± 10 psec to ± 0.5 sec (Typ.)
 Display Resolution (/div can be set to) 10 fsec/div to 10 sec/div
 Accuracy (at = 23 $\pm 5^{\circ}$ C, Typical)

In general, the following formula can be used to determine the accuracy, in seconds, of a specific group delay measurement:

$$\frac{\text{Phase Accuracy[deg]}}{360[\text{deg}] \times \text{Aperture[Hz]}}$$

Depending on the aperture, input level, and device length, the phase accuracy used in either incremental phase accuracy or worst case phase accuracy.

General Characteristics

Operating Conditions

When disk drive is in operation

Temperature 10 to 50 $^{\circ}$ C

Humidity (at wet bulb $\leq 29^{\circ}$ C, without condensation) 15% \leq RH \leq 80%

When disk drive is not in operation

Temperature 0 to 55 $^{\circ}$ C

Humidity (at wet bulb $\leq 29^{\circ}$ C, without condensation) 15% \leq RH \leq 95%

Altitude 0 to 4,500 meters (15,000 feet)

Warm Up Time 30 minutes

Non-operating Conditions

Temperature -40 to 60 $^{\circ}$ C

Humidity (at wet bulb $\leq 29^{\circ}$ C, without condensation) 15 % \leq 95 %

Altitude 0 to 15,240 meters (50,000 feet)

Safety Based on IEC-348, UL 1244 certified by CSA 231

EMI Based on CISPR-11 Group1 Class A and FTZ 526/527

Line Power

Voltage Selector	Line Voltage	Line Frequency	MAX. VA
115 V	90 to 132 V	47 to 66 Hz	350
230 V	198 to 264 V	47 to 66 Hz	350

Weight 27 kg (Typ.)

Cabinet Dimensions 425(W) \times 235(H) \times 553(D) mm (Typ.)

ESD

Air discharge 8 kV

Contact discharge 4 kV

Rear Panel Specifications

I/O Buses

HP-IB Interface

ANSI/IEEE 488.2 compatible. There is no address switch.

I/O Port

See Appendix C in the *Reference Manual*.

BNC Connectors

“EXT REF INPUT 10/N MHz” Connector

This inputs a frequency reference to phase lock the analyzer to an external frequency standard.

Applicable input signal characteristics are:

Frequency	$\frac{10}{N}$ MHz ± 10 ppm, (N = 1, 2, 5, 10) (Typ.)
Amplitude	0 ± 5 dBm (Typ.)
Nominal Impedance	50 Ω

“REF OVEN (OPTION 001)” Connector

This outputs a frequency standard if Option 001 is installed. Output signal specifications are:

Frequency (at 0 to 55 °C, 20 minutes after power ON)	10 MHz ± 1.0 ppm (Typ.)
Amplitude	2 ± 5 dBm (Typ.)
Nominal Impedance	50 Ω

“INT REF OUTPUT” Connector

This outputs a frequency reference to an external instrument to phase lock it to the analyzer.

Output signal specifications follow:

Frequency (at 23 ± 5 °C)	10 MHz ± 20 ppm (Typ.)
Amplitude	0 ± 5 dBm (Typ.)
Nominal Impedance	50 Ω

“EXT TRIGGER” Connector

This triggers a measurement sweep.

Trigger signal specifications follow (See Figure 3-1):

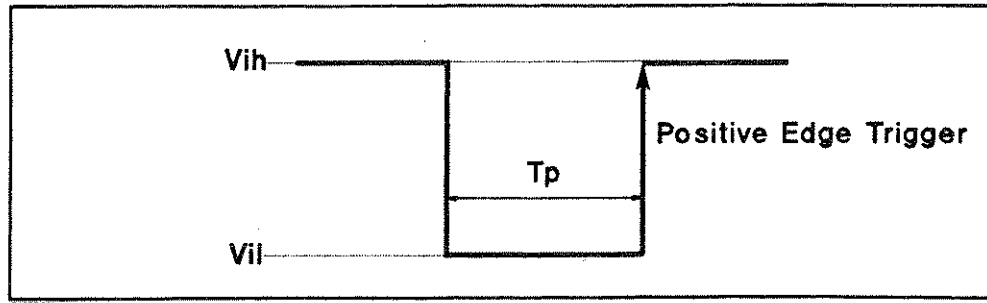

Figure 3-1. Trigger Signal

V_{ih}	+2 V to +5 V (Typ.)
V_{il}	0 V to +0.5 V (Typ.)
Sink current (I_s)	$I_s \leq 0.4$ mA (Typ.)
Pulse width (T_p)	$T_p \geq 20$ μ sec (Typ.)
Positive edge trigger	

“EXT PROG RUN/CONT” Connector

This externally triggers RUN/CONT of the Instrument BASIC program. The signal specifications are the same with the “EXT TRIGGER” connector.

Specifications when Option is Installed

Specifications When Option 003 Type N Connector Is installed

- The following specifications is changed.

Input Connector

Rch	BNC female, 50 Ω (nominal)
Ach	Type N female, 50 Ω (nominal)
Probe Power	+15 V (150 mA), -12.6 V (80 mA), GND (Typ.)

Specifications When Option 004 Delete Rch Is Installed

- The following specifications is deleted.

- “Power Splitter” in the “Output Power Characteristics” of the “SOURCE”
- “Input Crosstalk” in the “Input Characteristics” of the “Receiver”
- “Ratio Characteristics” in the “Magnitude Characteristics” of “Receiver”
- “Frequency Response”, “Trace Noise”, and “Stability” in the “Phase Characteristics” of the “Receiver”

- The following specifications is changed.

Output Return Loss	5 dB (Typ.)
Output Connector	One channel (RF OUT)

Input Connector	One Channel (Ach)
Measurement Mode	A
Magnitude Dynamic Accuracy (At $23 \pm 5^\circ\text{C}$, 20 Hz IF BW, assumption: reference is -20 dBm Ach input level, right after measuring reference)	
$0 \text{ dBm} \geq \text{Input Level} > -10 \text{ dBm}$	$\pm 0.4 \text{ dB}$
$-10 \text{ dBm} \geq \text{Input Level} \geq -60 \text{ dBm}$	$\pm 0.1 \text{ dB}$
$-60 \text{ dBm} > \text{Input Level} \geq -70 \text{ dBm}$	$\pm 0.2 \text{ dB}$
$-70 \text{ dBm} > \text{Input Level} \geq -80 \text{ dBm}$	$\pm 0.6 \text{ dB}$
Magnitude Stability	$0.05 \text{ dB}/^\circ\text{C}$ (Typ.)
Phase Dynamic Accuracy (at $23 \pm 5^\circ\text{C}$, 20 Hz IF BW, assumption: reference is -20 dBm Ach input level, right after measuring reference)	
$0 \text{ dBm} \geq \text{input level} > -10 \text{ dBm}$	$\pm 3 \text{ degree}$
$-10 \text{ dBm} \geq \text{input level} \geq -60 \text{ dBm}$	$\pm 1.5 \text{ degree}$
$-60 \text{ dBm} > \text{input level} \geq -70 \text{ dBm}$	$\pm 2.4 \text{ degree}$
$-70 \text{ dBm} > \text{input level} \geq -80 \text{ dBm}$	$\pm 3.6 \text{ degree}$
Phase Stability	$\pm 1 \text{ degree}/^\circ\text{C}$ (Typ.)

Furnished Accessories

Accessory	HP part number	Accessory	HP part number
Operation Manual	87510-90000	BNC Adapter ²	1250-1859
Maintenance Manual	87510-90030	Keyboard Template ³	08751-87111
Performance Test Program	87510-87001	ASCII Keyboard ³	HP 46021A
Sample Program Disk	87510-87002	ITF Keyboard Cable ³	46020-60001
BNC Cable	8120-1838	HP Instrument BASIC Manual Set ³	E2083-90000
Power Cable ¹			

1 power cable depends on where the instrument is used, see figure on the next page

2 Only option 001.

3 Only option 002.

<p>OPTION 900 United Kingdom</p>  <p>Plug: BS 1363A, 250V Cable: HP 8120-1351</p>	<p>OPTION 901 Australia/New Zealand</p>  <p>Plug: NZSS 198/AS C112, 250V Cable: HP 8120-1369</p>
<p>OPTION 902 European Continent</p>  <p>Plug: CEE-VII, 250V Cable: HP 8120-1688</p>	<p>OPTION 903 U.S./Canada</p>  <p>Plug: NEMA 5-15P, 125V, 15A Cable: HP 8120-1378</p>
<p>OPTION 904 U.S./Canada</p>  <p>Plug: NEMA 6-15P, 250V, 15A Cable: HP 8120-0698</p>	<p>OPTION 905* Any country</p>  <p>Plug: CEE 22-VI, 250V Cable: HP 8120-1396</p>
<p>OPTION 906 Switzerland</p>  <p>Plug: SEV 1011.1959-24507 Type 12, 250V Cable: HP 8120-2104</p>	<p>OPTION 912 Denmark</p>  <p>Plug: DHCR 107, 220V Cable: HP 8120-2956</p>
<p>OPTION 917 India/Republic of S.Africa</p>  <p>Plug: SABS 164, 250V Cable: HP 8120-4211</p>	<p>OPTION 918 Japan</p>  <p>Plug: JIS C 8303, 125V, 15A Cable: HP 8120-4753</p>
<p>NOTE: Each option number includes a 'family' of cords and connectors of various materials and plug body configurations (straight, 90° etc.).</p> <p>* Plug option 905 is frequently used for interconnecting system components and peripherals.</p>	

Figure 3-2. Power Cables Supplied

System Overview

System Overview

Network analyzers measure the reflection and transmission characteristics of devices and networks by applying a known swept signal and measuring the response of the test device. The signal transmitted through the device or reflected from its input is compared with the incident signal generated by a swept RF source. The signals are applied to a receiver for measurement, signal processing, and display. A network analyzer system consists of a source, signal separation devices, a receiver, and a display.

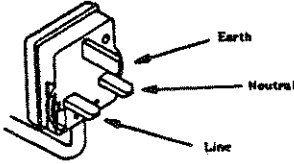
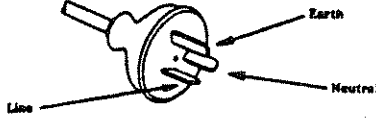
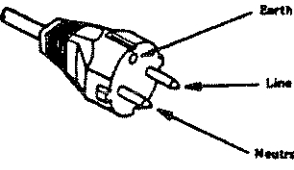
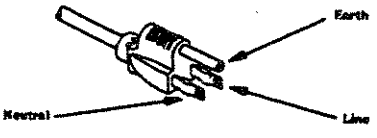
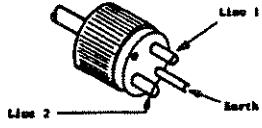
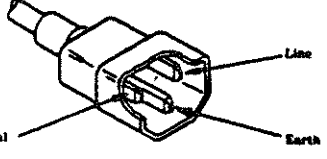
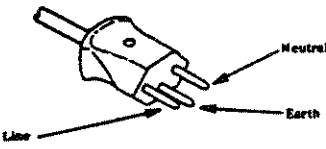
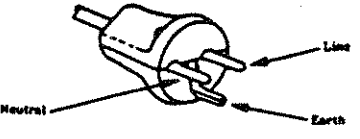
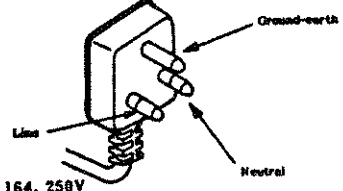
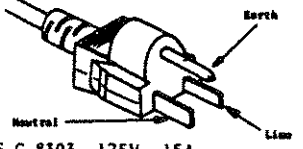
The HP 87510A Gain/Phase analyzer integrates a high resolution synthesized RF source with a built-in power splitter and a dual channel two-input receiver to measure and display magnitude, phase, and group delay of transmitted power. The HP 87510A has the capability of programming the measurement sequence and controlling other HP-IB instruments without an external controller. Other options are explained in Chapter 2. Figure 4-1 is a simplified block diagram of the gain phase analyzer system. A detailed block diagram of the analyzer is provided in the *Service Manual* (HP Part Number:87510-90031), together with theory of operation.

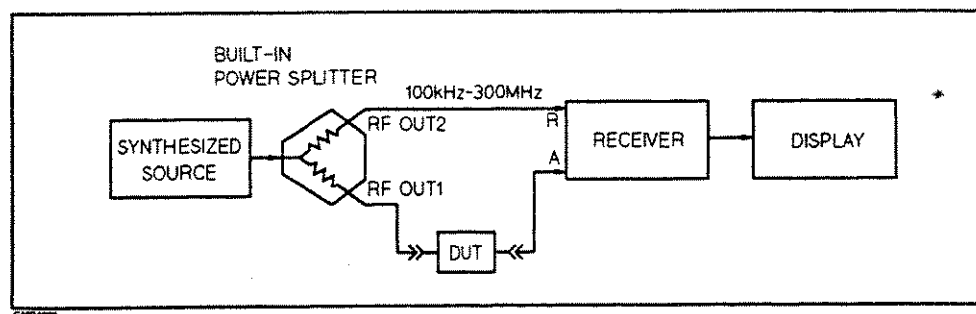

Figure 4-1. Simplified Block Diagram of the Network Analyzer System

Overall Operation

The source RF signal is transmitted through the device under test (DUT) and is then applied to receiver input A. The signal at receiver input A is compared to the original signal at receiver input R to characterize the DUT's transmission response.

The Built-In Synthesized Source

The analyzer's built-in synthesized source produces a swept RF signal in the range of 1 kHz to 300 MHz. To achieve frequency accuracy and phase measuring capability, the analyzer is phase-locked to a highly stable crystal oscillator.

The Built-in Power Splitter

The analyzer has a power splitter separate RF output signal to reference signal and incident signal.

The Receiver Block

The receiver block contains identical mixers for the R, and A inputs. The signals are mixed to produce a 10 kHz IF (intermediate frequency) which is converted to digital data for further processing. Both amplitude and phase information are measured simultaneously, regardless of what is displayed on the CRT.

The Microprocessors

The microprocessors take the raw data and perform all the required error correction, formatting, scaling, and marker operations, according to the instructions from the front panel. The formatted data is then displayed on the CRT. The data processing sequence is described below.

Data Processing

Overview

The analyzer's receiver converts the R, and A input signals into useful measurement information. This conversion occurs in two main steps. First, the swept high frequency input signals are translated to fixed low frequency IF signals, using analog mixing techniques. See "Theory of Operation" in the *Service Manual* for details. Second, the IF signals are converted into digital data by an analog-to-digital converter (ADC). From this point on, all further signal processing is performed mathematically by the analyzer's microprocessors. The following paragraphs describe the sequence of math operations and the resulting data arrays as the information flows from the ADC to the display. They provide a good foundation for understanding most of the response functions, and the order in which they are performed.

Figure 4-2 is a data processing flow diagram that represents the flow of numerical data from IF detection to display. The data passes through several math operations, denoted in the figure by single-line boxes. Most of these operations can be selected and controlled from the front panel RESPONSE block menus. The data is also stored in data arrays along the way, denoted by double-line boxes. These arrays are places in the flow path where data is accessible via HP-IB, using the built-in disk drive, and the RAM disk memory.

Important Concepts

- **Stimulus** is whatever is being measured on the display x-axis (frequency).
- A **data point** or **point** is a single piece of data representing a measurement at a single stimulus value. Most data processing operations are performed point-by-point; some involve more than one point.
- A **sweep** is a series of consecutive data point measurements, taken over a sequence of stimulus values. A few data processing operations require that a full sweep of data is available. The number of points per sweep is user defined, while the default number of points is 201. Note that the meaning of the stimulus values (independent variables) can change, depending on the *sweep type*, although this does not generally affect the data processing path. Examples of sweep types are linear frequency, logarithmic frequency and

frequency list mode. The frequency list mode allows you to choose specific stimulus points to be measured.

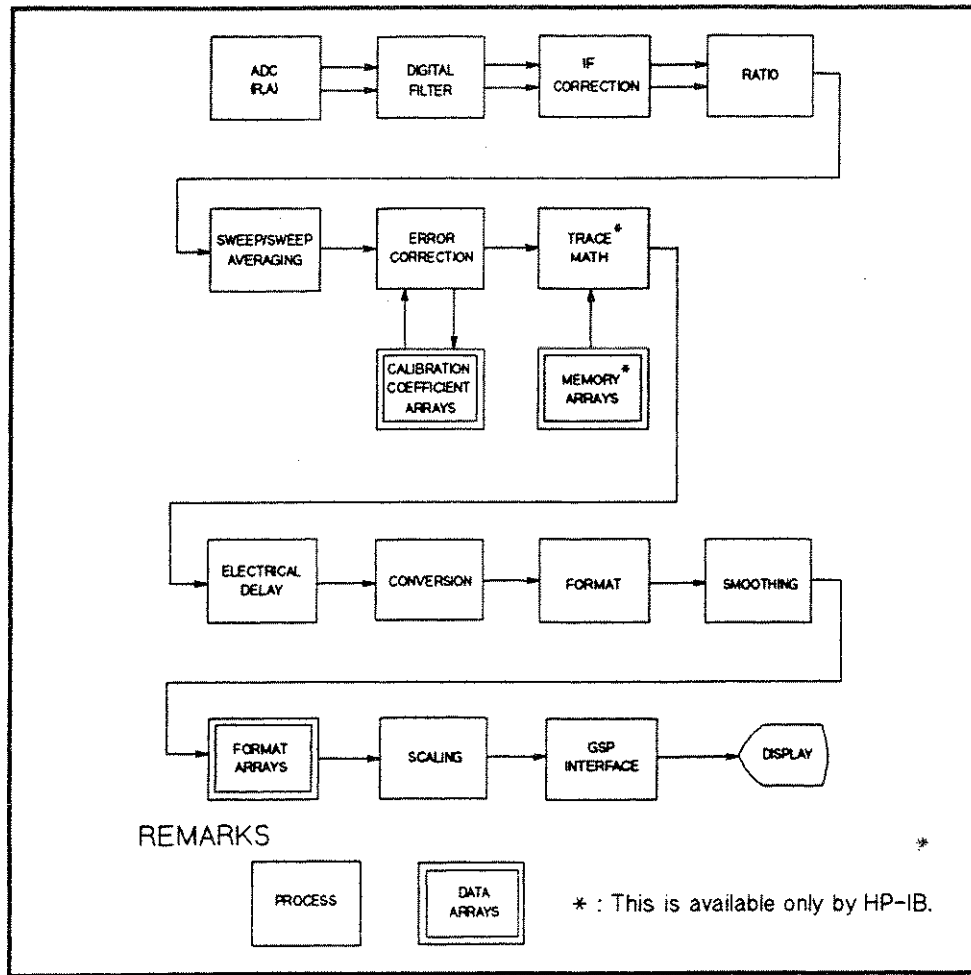

Figure 4-2. Data Processing Flow Diagram

Note



While only a single flow path is shown, two identical paths are available, corresponding to channel 1 and channel 2. When the channels are uncoupled, each channel can be independently controlled, so that the data processing operations for one can be different from the other.

Processing Details

The ADCs

The ADCs at both ports (R and A) convert an analog signal, which is already down-converted to a fixed low frequency IF, into digital data. See “MEAS Key” in Chapter 9 for more information on inputs.

Digital Filter

The digital filter detects the IF signal by performing a discrete Fourier transform (DFT) on the digital data. The samples are converted into complex number pairs, real plus imaginary, $R+jI$, which represent both the magnitude and phase of the IF signal. The filter shape can be

altered by selecting the IF bandwidth from among 20, 200, 1 k, 4 kHz and 8 kHz, which is a highly effective technique for noise reduction. See "**AVG** Key" in Chapter 9 for information on different noise reduction techniques.

IF Correction

This process digitally corrects for frequency response errors in the analog down conversion path.

Ratio Calculations

These are performed if the selected measurement is a ratio of *A* and *R* inputs. This is simply a complex divide operation. If the selected measurement is absolute (e.g. *A* or *R*), no operation is performed. The *R* and *A* values are also split into channel data at this point. See "**MEAS** Key" in Chapter 9 for more information.

Sweep-to-sweep Averaging

This is one of the noise reduction techniques. This calculation involves taking the complex exponential average of up to 999 consecutive sweeps. See "**AVG** Key" in Chapter 9.

Vector Error Correction (Accuracy Enhancement)

When a measurement calibration has been performed and correction is turned on, error correction removes repeatable systematic errors, stored in the calibration coefficient arrays, from the measurement data. This can vary from simple vector normalization to 3-term correction. See Chapter 10 for details.

The calibration coefficient arrays themselves are created during a measurement calibration. These are subsequently used whenever correction is ON, are accessible using by HP-IB, and can be saved to the built-in disk drive or the RAM disk memory.

The results of error correction are stored in the data arrays as complex number pairs. These arrays are accessible by HP-IB, and can be saved to the built-in disk drive and the RAM disk memory.

The Delay Block (Electrical Delay)

This involves adding or subtracting a linear phase in proportion to frequency. This is equivalent to "line-stretching" or artificially moving the measurement reference plane. See "**SCALE REF** Key" in Chapter 9 for details.

Conversion Transforms

Transforms measurement data into equivalent complex impedance (*Z*) or admittance (*Y*) values, to inverse parameters (*R/A*, *1/A* or *1/R*), or to phase multiples of 4, 8, or 16. See "Conversion Menu" in Chapter 9.

Formatting

This converts the complex number pairs into a scalar representation for display, according to the selected format. This includes group delay calculations. These formats are often easier to interpret than the complex number representation. (Polar chart format is not affected by the scalar formatting.) Note that after formatting, it is impossible to recover the complex data. See "**FORMAT** Key" in Chapter 9 for information on the different formats available and on group delay principles.

Smoothing

This is one of the noise reduction techniques used to smooth out noise on the trace. When smoothing is ON, each point in a sweep is replaced by the moving average value of several adjacent (formatted) points. The number of points included depends on the user defined smoothing aperture. The effect is similar to video filtering. See "**AVG** Key" in Chapter 9 for information about smoothing.

Format Arrays

The results so far are stored in the format arrays. It is important to note that marker values and marker functions are all derived from the format arrays. Limit testing is also performed on the formatted data. The format arrays are accessible by HP-IB, and can be saved to the built-in disk drive or the RAM disk memory.

Scaling

These operations prepare the formatted data for display on the CRT. This is where the reference line position, reference line value, and scale calculations are performed, as appropriate for the format being used. See "**SCALE REF** Key" in Chapter 9.

Display Memory

The display memory stores the display image for presentation on the display. The information here includes graticules, annotation, and softkey labels - everything visible on the display. When the display is printed or plotted, the information sent to the printer or plotter is taken from display memory. Finally, the display memory data is sent to the display.

of

of

of

Front and Rear Panel

Introduction

This chapter describes the analyzer operation using its front panel controls, and explains the use of softkey menus. It provides illustrations and descriptions of the front panel features, the CRT display and its labels, and the rear panel features and connectors.

Analyzer functions are activated from the front panel by the operator using front panel keys or softkeys. In this manual, all front panel keys and softkey labels are shown as **Hardkey** and **Softkey**.

Active Function

The function currently activated is called the active function, and is displayed in the active entry area at the upper left of the display. As long as a function is active it can be modified with the ENTRY keypad (See "Entry Block Keys" in Chapter 7). A function remains active until another function is selected, or **ENTRY OFF** is pressed.

Front Panel Keys and Softkey Menus

Some of the front panel keys change instrument functions directly, and others provide access to additional functions available in softkey menus. Softkey menus are lists of up to eight related functions that can be displayed in the softkey label area at the right-hand side of the display. The eight keys to the right of the CRT are the softkeys. Pressing one of the softkeys selects the adjacent menu function. This either executes the labeled function and makes it the active function, causes instrument status information to be displayed, or presents another softkey menu.

Some of the analyzer's menus are accessed directly from front panel keys, and some from other softkey menus. For example, the stimulus menu accessed by pressing the **MENU** key presents all the stimulus functions such as sweep type, number of points, power, sweep time, and trigger. Pressing **NUMBER of POINTS** allows the required number of points per sweep to be entered directly from the number pad. The **RETURN** softkeys returns to previous menus, while **DONE** both indicates completion of a specific procedure and returns to an earlier menu.

Usually, whenever a menu changes, the present active function is cleared, unless it is an active marker function.

Softkeys that are Joined by Vertical Lines

In cases where several possible choices are available for a function, they are joined by vertical lines. For example, in the input menu under the **MEAS** key, the available inputs and input combinations are listed: A, R, A/R, and only one can be selected at a time. When a selection has been made from the listed alternatives, that selection is underlined until another selection is made.

Softkeys That Toggle ON or OFF

Some softkey functions can be toggled ON or OFF, for example averaging, and this is indicated in the softkey label. The current state, ON or OFF, is capitalized in the softkey label.

Example:

AVERAGING ON off

The word ON is capitalized, showing that averaging is currently ON.

AVERAGING on OFF

The word OFF is capitalized, showing that averaging is currently OFF.

Softkeys that Show Status Indications in Brackets

Some softkey labels show the current status of a function in brackets. These include simple toggle functions and status-only indicators. An example of a toggled function is the **PLOT SPEED [FAST]** or **PLOT SPEED [SLOW]** softkey. The **IF BW** softkey is an example of a status-only indicator, where the selected value of the IF bandwidth is shown in brackets in the softkey label.

Function Key Blocks

The front panel keys that provide access to softkey menus are grouped into the **STIMULUS**, **RESPONSE**, and **INSTRUMENT STATE** function blocks.

Stimulus Block

The stimulus block keys and softkey menus control all the functions of the test signal source.

Response Block

The response block keys and softkey menus control the measurement and display functions specific to the active channel.

Instrument State Block

The instrument state block keys and softkey menus control channel-independent system function such as printing and plotting, save and recall, and HP-IB controller mode. In addition, major features such as limit testing, BIN sorting and Instrument BASIC are accessed under the **SYSTEM** key.

Instrument BASIC allows BASIC program entry using a full keyboard, to automate DUT measurement. Instrument BASIC may also be configured to run automatically at power on. This function also allows the operator to control external HP-IB instrument from the analyzer. *Using HP Instrument BASIC with HP 87510A* describes this feature.

HP-IB Control

The functions accessible from the front panel can also be accessed remotely by an external controller using HP-IB, or the Instrument BASIC function. Equivalent HP-IB commands are available for most of the front panel keys and softkey menu selections. The HP-IB programming command equivalent to each front panel and softkey function is provided in parentheses after the first reference. Additional information about HP-IB programming is provided in *HP-IB Programming Manual*.

Information on Keys and Softkeys

The following chapters describe all the front panel keys and softkey menus in detail. The purpose and use of each function is detailed, together with expected indications and results, allowable values, and possible limitations. This information is presented in function block order. Each function block is illustrated and described in general terms. This is followed by information about each front panel key in the function block, together with a map and description of all the menus accessed from that key. Each menu is illustrated, and each softkey function in each menu is explained in detail. A complete map of the softkey menu structure is provided in Appendix E at the end of this reference, together with an alphabetical index.

Front Panel Features

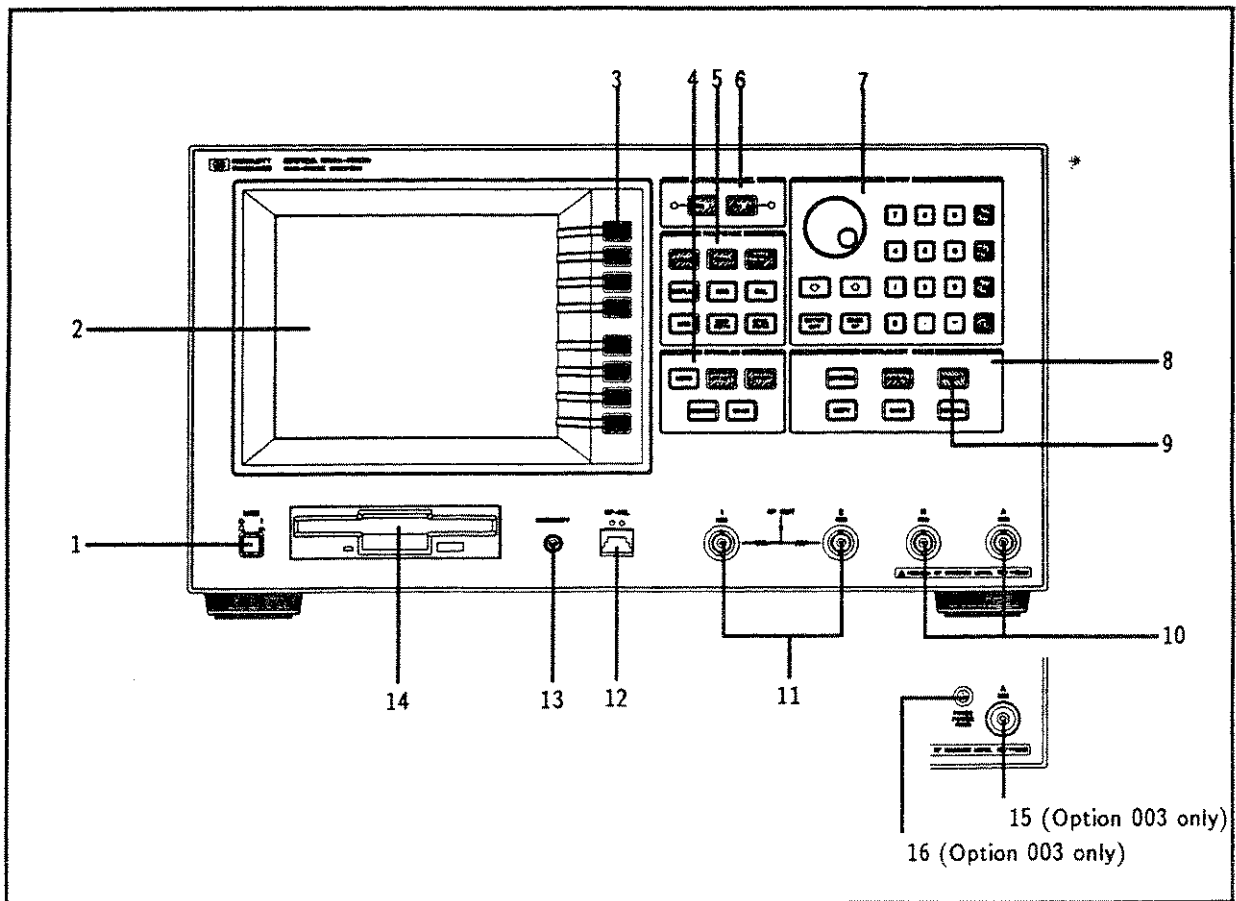

Figure 5-1. HP 87510A Front Panel

Figure 5-1 illustrates the following features and function blocks of the analyzer front panel. These features are described in more detail in this and subsequent chapters.

Caution



A properly grounded AC outlet is mandatory when operating the analyzer. Operating the instrument with an improperly grounded or floating ground prong **WILL DAMAGE THE INSTRUMENT!**

1. *LINE switch*. This controls AC power to the analyzer. 1 is ON, 0 is OFF.
2. *CRT display*. This is used for display of data traces, measurement annotation, softkey labels, and other information. The display is divided into specific information areas, illustrated in Figure 5-2.
3. *Softkeys*. These keys expand the capabilities of the analyzer with additional functions beyond those of the front panel keys. They provide access to menu selections displayed on the CRT.
4. *STIMULUS function block*. The keys in this block control the RF signal from the analyzer's source, and other stimulus functions.
5. *RESPONSE function block*. The keys in this block control the measurement and display functions of the active display channel.
6. *ACTIVE CHANNEL keys*. These keys select the active channel from two independent display channels. Any functions then entered apply to this active channel.
7. *The ENTRY block* includes the knob, the step \uparrow \downarrow keys, and the number pad. These keys are for entering numerical data and controlling the marker.
8. *INSTRUMENT STATE function block*. These keys control channel-independent system functions such as the following:
 - Limit testing (under the **SYSTEM** key).
 - Bin sorting (under the **SYSTEM** key).
 - Real time clock setting (under the **SYSTEM** key).
 - Instrument BASIC (under the **SYSTEM** key).
 - Changing the HP-IB addresses used by the analyzer when controlling external devices (printer, plotter). This is done through the **LOCAL** key.
 - Printing and plotting (under the **COPY** key).
 - Save/Recall, under their respective keys.
9. **PRESET** key. This key returns the instrument to a known standard preset state from any step of any manual procedure. A complete listing of the instrument preset conditions is provided in Appendix B.
10. *Inputs R and A*. These receive input signals from a test set, source, or device under test. Input R is used as the reference input. The input impedance of each input is 50 Ω .
11. *RF OUT connector 1 and 2*. These connect the RF output signal from the analyzer's internal source through the built-in power splitter. The output impedance at this connector is 50 Ω .
12. *Intensity*. This adjusts the intensity of the CRT display.
13. *HP-HIL connector*. This connects the keyboard (Option 002) to use Instrument BASIC.
14. *Built-in Flexible Disk Drive*. This stores the measurement data, instrument status, list sweep tables, and Instrument BASIC programs. The applicable disk formats are LIF (logical interchange format) and DOS format.

15. *Type-N Input A Connector (Option 003 only)*. Option 003 changes A channel input to type-N connector.
16. *Probe Power Connector (Option 003 only)*. This connector (fused inside the instrument) supplies power to an active probe for in-circuit measurements of AC circuits. Applicable active probes are described in Chapter 2.

CRT Display

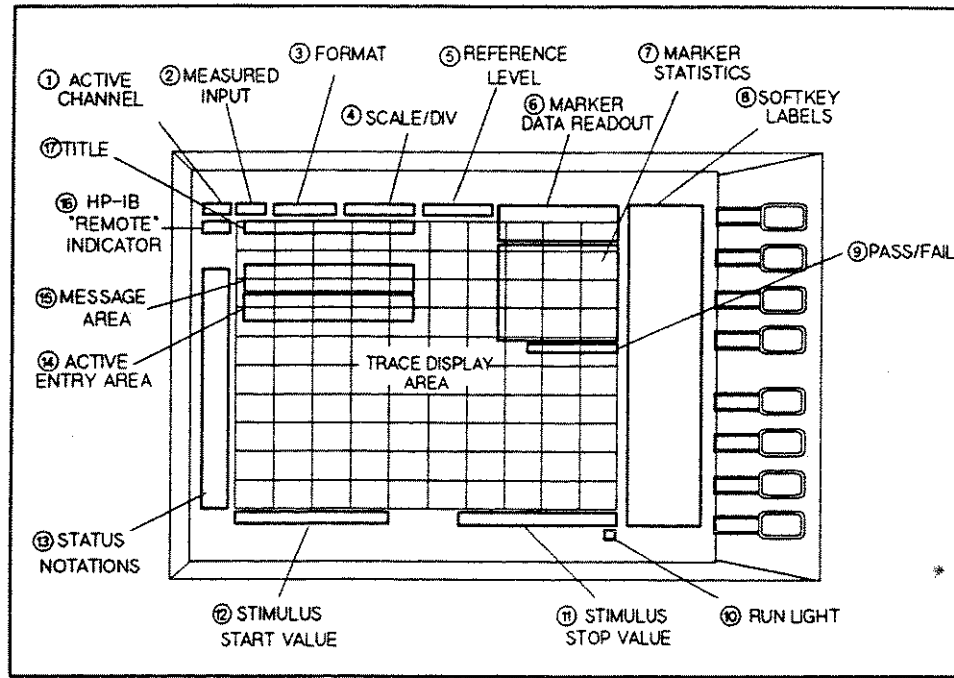

Figure 5-2. CRT Display (Single Channel, Cartesian Format)

The CRT displays the grid on which the measurement data is plotted, the currently selected measurement traces, and other information describing the measurement. Figure 5-2 illustrates the locations of the different CRT information labels, described below.

In addition to the full-screen display shown in Figure 5-2, a split display is available, as described under "**DISPLAY** Key" in Chapter 9. In this case, information labels are provided for each half of the display.

Several different display formats for different measurements are illustrated and described in "**FORMAT** Key" in Chapter 9.

The screen can also be used as the Instrument BASIC display. Instrument BASIC uses a full-screen display or a half-screen display below the graticule display as a text screen, and uses all of the screen as a graphics screen.

The following describe the information labels in detail.

1. *Active Channel* is the number of the current active channel, selected with the **ACTIVE CHANNEL** keys. If dual channel is ON with an overlaid display, both channel 1 and channel 2 appear in this area.

2. *Measured Input(s)* shows input, or ratio of inputs currently measured, as selected using the **MEAS** key. The current display memory status is also indicated in this area.
3. *Format* is the display format selected using the **FORMAT** key.
4. *Scale/Div* is the scale selected using the **SCALE REF** key, in units appropriate for the current measurement.
5. *Reference Level* is the value of a reference line in Cartesian formats or the outer circle in polar formats, selected using the **SCALE REF** key. However the reference line is invisible, it is indicated by a small triangle adjacent to the graticule at the left.
6. *Marker Data Readout* are the values of the active marker, in units appropriate to the current measurement. See Chapter 11.
7. *Marker Statistics, Width Value* are statistical marker values determined using the menus accessed with the **MKR FCTN** key. See Chapter 11 .
8. *Softkey Labels* are menu labels displayed on the CRT that redefine the function of the softkeys immediately to the right of the CRT.
9. *Pass/Fail* are used for limit testing using limit lines. See "Limit Line and Limit Testing" in Chapter 12.
10. *RUN LIGHT* indicates the status of the Instrument BASIC program.
 - (blank) Program stopped; can execute commands; CONTINUE not allowed.
 - Program paused; can execute commands; CONTINUE is allowed.
 - ? BASIC program waiting for input from keyboard; cannot execute commands.
 - * This indication has two possible meanings:
 - a. Program running; can NOT execute commands. CONTINUE not allowed.
 - b. System executing commanded entered from keyboard; can NOT enter commands.
11. *Stimulus Stop Value* is the stop frequency of the source. When the stimulus is in center/span mode, the span is shown in this space. The stimulus values can be blanked, as described under "**DISPLAY** Key" in Chapter 9.
12. *Stimulus Start Value* is the start frequency of the source. When the stimulus is in center/span mode, the center stimulus value is shown in this space.

13. *Status Notations* is the current status of various functions for the active channel. The following notations are used:

- Avg** Sweep-to-sweep averaging is ON. The averaging count is shown immediately below (see “**AVG** Key” in Chapter 9).
- Cor** Error correction is ON (see Chapter 10).
- C?** Stimulus parameters have changed, and interpolated error correction is ON (see “**CAL** Key” in Chapter 10).
- C!** Stimulus parameters have changed, and interpolated error correction is not available (see “**CAL** Key” in Chapter 10).
- Del** Electrical delay, port extension, or phase offset has been added or subtracted (see “**SCALE REF** Key” in Chapter 9).
- Ext** Waiting for an external trigger.
- Hld** Hold sweep (see “Trigger Menu” in Chapter 8).
- man** Waiting for manual trigger.
- Smo** Trace smoothing is ON (see “**AVG** Key” in Chapter 9).
- Svc** A service mode is turned ON. If this notation is shown, the measurement data will be out of specifications. (*See Maintenance Manual.*)
- *** Source parameters changed: measured data in doubt until a complete fresh sweep has been taken.

14. *Active Entry Area* displays the active function and its current value.

15. *Message Area* displays prompts or error messages.

16. *HP-IB “REMOTE” Indicator* displays “RMT” when the analyzer is in the remote state.

17. *Title* is a descriptive alpha-numeric string title defined by the user and entered as described at “Title Menu” in Chapter 9 under “**DISPLAY** Key” in Chapter 9.

Note

The information provided here applies to Cartesian display formats. In polar chart display format, the labeling may differ.



Rear Panel Features and Connectors

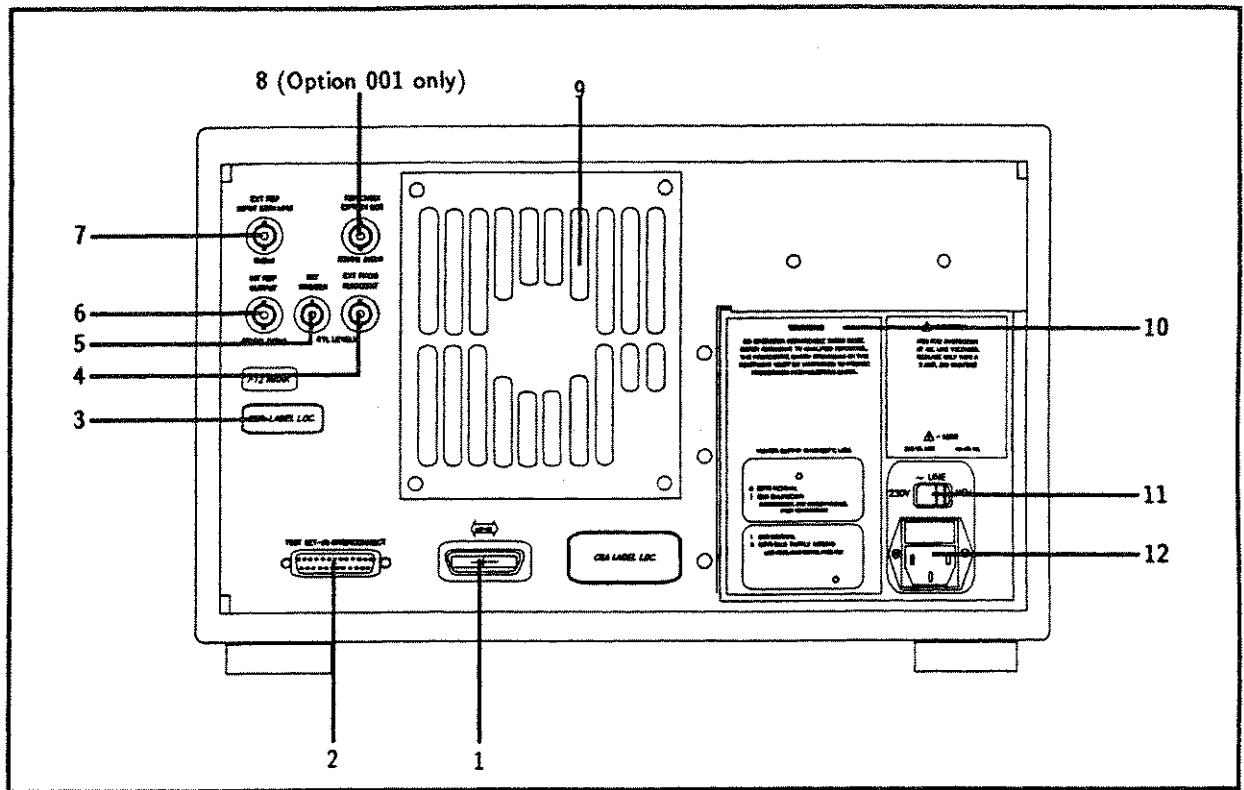

Figure 5-3. HP 87510A Rear Panel

Figure 5-3 illustrates the features and connectors of the rear panel, described below. Requirements for input signals to the rear panel connectors are provided in the General Characteristics table of the General Information and Specifications section.

1. **HP-IB connector.** This connects the analyzer to an external controller and other instruments in an automated system. This connector is also used when the analyzer itself is the controller of compatible peripherals. See Chapter 15.
2. **I/O port connector.** See Appendix C and D for complete information.
3. **Serial number plate.** For information about serial numbers, see "Instruments Covered by This Manual" in Chapter 2.
4. **EXT PROG RUN/CONT connector.** This externally triggers RUN or CONT of the Instrument BASIC program. At the positive-going edge of a pulse more than 20 μsec wide in the LOW state will trigger RUN or CONT. The signal is TTL-compatible.
5. **EXT TRIGGER connector.** This triggers a measurement sweep. At the positive-going edge of a pulse with more than 20 μsec wide in the LOW state will start a measurement. The signal is TTL-compatible. To use this connector, set the trigger mode to external using softkey functions (see "Trigger Menu" in Chapter 8).
6. **INT REF OUTPUT connector.** This connects a frequency reference input of an external instrument to phase lock it to the HP 87510A.
7. **EXT REF INPUT connector.** This inputs a frequency reference signal to phase lock the analyzer to an external frequency standard for increased frequency accuracy.

When the HP 87510A is equipped with the external oven (Option 001), this connector must be connected to the REF OVEN connector.

The external frequency reference feature is automatically enabled when a signal is connected to this input. When the signal is removed, the analyzer automatically switches back to its internal frequency reference.

8. *REF OVEN (Option 001) connector* connects to the EXT REF INPUT connector, when Option 001 is installed. Option 001 improves the frequency accuracy and stability of the analyzer.
9. *Fan.* This provides forced-air cooling for the analyzer.
10. *Safety warnings.*
11. *Line voltage selector switch.* See "Line Voltage" in the User's Guide.
12. *Power cord receptacle, with fuse.*



Active Channel Block

Active Channel Keys

The analyzer has two digital channels for independent measurement and display of data. Two different sets of data can be measured simultaneously, for example the reflection and transmission characteristics of a device, or one measurement with two different frequency spans. The data can be displayed separately or simultaneously, as described below.

The HP-IB programming command is shown in parenthesis following the key or softkey.

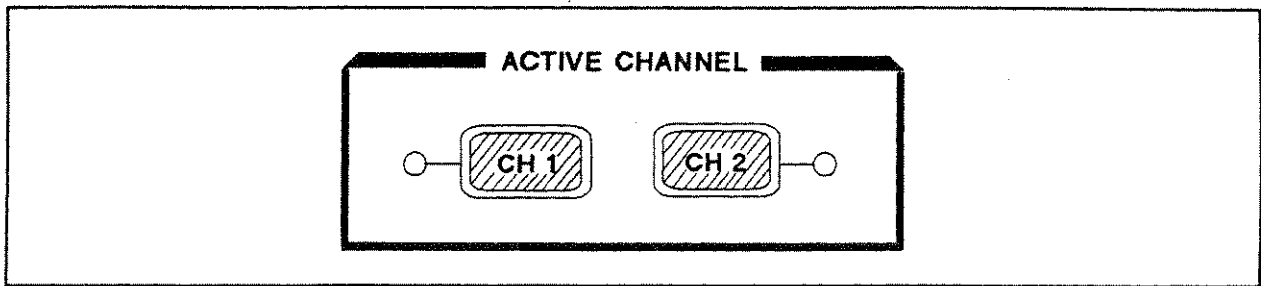

C4006001

Figure 6-1. Active Channel Keys

The **CH 1** (CHAN1) and **CH 2** (CHAN2) keys illustrated in Figure 6-1 select which channel is the *active channel*. This is the channel currently controlled by the front panel keys, and its trace and data annotations are displayed on the display. All channel specific functions selected apply to the active channel. The current active channel is indicated by an amber LED adjacent to the corresponding channel key.

The analyzer has dual trace capability, so that both the active and inactive channel traces can be displayed, either overlaid or on separate graticules (split display). The dual channel and split display features are available in the display menus. See Chapter 9 for illustrations and descriptions of the different display capabilities.

Stimulus values can be coupled or uncoupled between the two channels, independent of the dual channel and split display functions. Refer to "**MENU** Key" in Chapter 8 for a listing of the source values that are coupled in stimulus coupled mode.

Another coupling capability is coupled markers. Measurement markers can have the same stimulus values for the two channels, or they can be uncoupled for independent control of each channel. Refer to Chapter 11 for more information about markers.



Entry Block

Entry Block Keys

The ENTRY block, illustrated in Figure 7-1, provides the numeric and units keypad, the knob, and the step keys. These are used in combination with other front panel keys and softkeys to modify the active entry, to enter or change numeric data, and to change the value of the active marker. In general the keypad, knob, and step keys can be used interchangeably.

Before a function can be modified, it must be made the active function by pressing a front panel key or softkey. It can then be modified directly with the knob, the step keys, or the digits keys and a terminator, as described below.

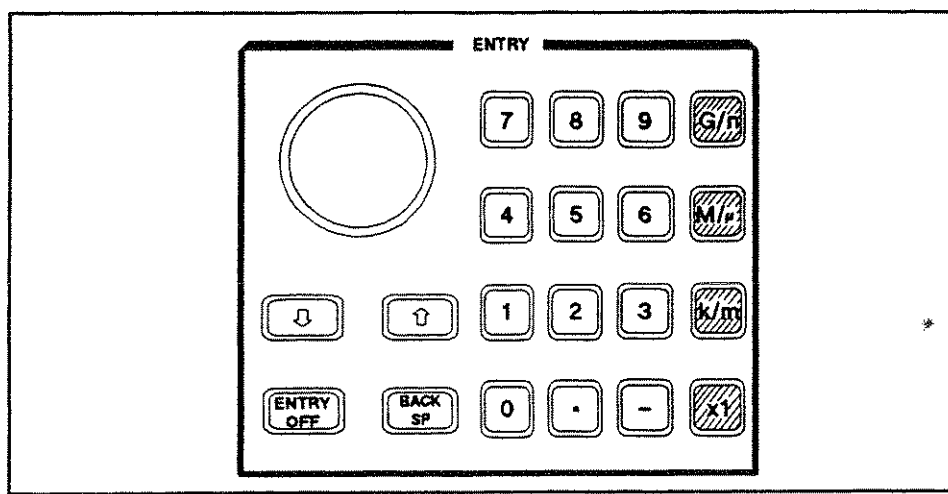

Figure 7-1. Entry Block

The numeric keypad selects digits, decimal point, and minus sign for numerical entries. A units terminator is required, as described below. The HP-IB programming command is shown in parenthesis following the key or softkey.

The units terminator keys are the four keys in the right-hand column of the keypad. These specify units of numerical entries from the keypad and at the same time terminate the entries. A numerical entry is incomplete until a terminator is supplied, and this is indicated by the data entry arrow "←" pointing at the last entered digit in the active entry area. When the units terminator key is pressed, the arrow is replaced by the units selected. The units are abbreviated on the terminator keys as follows:

G/n (G, N, KEY 43)	Giga/nano ($10^9 / 10^{-9}$)
M/μ (MA, U, KEY 42)	Mega/micro ($10^6 / 10^{-6}$)
k/m (K, M, KEY 41)	kilo/milli ($10^3 / 10^{-3}$)
x1 (KEY 40)	basic units: dB, dBm, degrees, seconds, Hz, or dB/GHz (may be used to terminate unitless entries such as averaging factor). No HP-IB commands are required.

Note

The suffix unit MHZ is a special case which should not be confused with MAHZ (megahertz) or mHZ (microhertz).



The knob adjusts continuously to current values for various functions such as scale, reference level, and others. If a marker is turned on, and no other function is active, the knob can adjust the marker position. Values changed by the knob are effective immediately, and require no units terminator.

The step keys **↓** (KEY 24) and **↑** (KEY 25) step the current value of the active function up or down. The steps are predetermined and cannot be altered. No units terminator is required with these two keys.

ENTRY OFF (KEY 26) clears and turns off the active entry area, as well as any displayed prompts, error messages, or warnings. Use this function to clear the display before plotting. This key also prevents changing of active values by accidentally moving the knob. The next selected function turns the active entry area back on.

BACK SPACE key (KEY 27) deletes the last entry, or the last digit entered from the numeric keypad.

Stimulus Function Block

Introduction

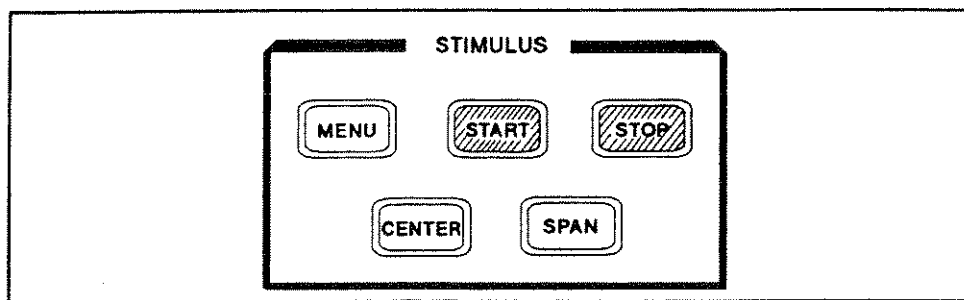

Figure 8-1. Stimulus Function Block

The stimulus function block keys and associated menus define and control the source RF output signal to the device under test (DUT). The source signal can be swept over any portion of the instrument's frequency range. The menus set all other source characteristics such as sweep time and resolution, source RF power level, and the number of data points taken during the sweep.

START, STOP, CENTER, and SPAN Keys

The HP-IB programming command is shown in parenthesis following the key or softkey.

START (STAR)

STOP (STOP)

CENTER (CENT)

SPAN (SPAN)

These keys define the frequency range of the stimulus. The range can be expressed as either Start/Stop or Center/Span. When one of these keys is pressed, its function becomes the active function. The value is displayed in the active entry area and can be changed with the knob, step keys, or numeric keypad. Current stimulus values for the active channel are also displayed along the bottom of the graticule. Frequency values can be a blank for security purposes, using the display menus.

The preset start and stop stimulus values are set to 100 kHz and 300 MHz respectively. The allowable frequency range is 1 kHz to 300 kHz.

Because the display channels are independent, the stimulus signals for the two channels can be uncoupled and their values set independently. The values are then displayed separately on the display if the analyzer is in dual channel display mode. In the uncoupled mode with

dual channel display the analyzer takes alternate sweeps to measure the two sets of data. Channel stimulus coupling is explained in this chapter, and dual channel display capabilities are explained in Chapter 9 .

MENU Key

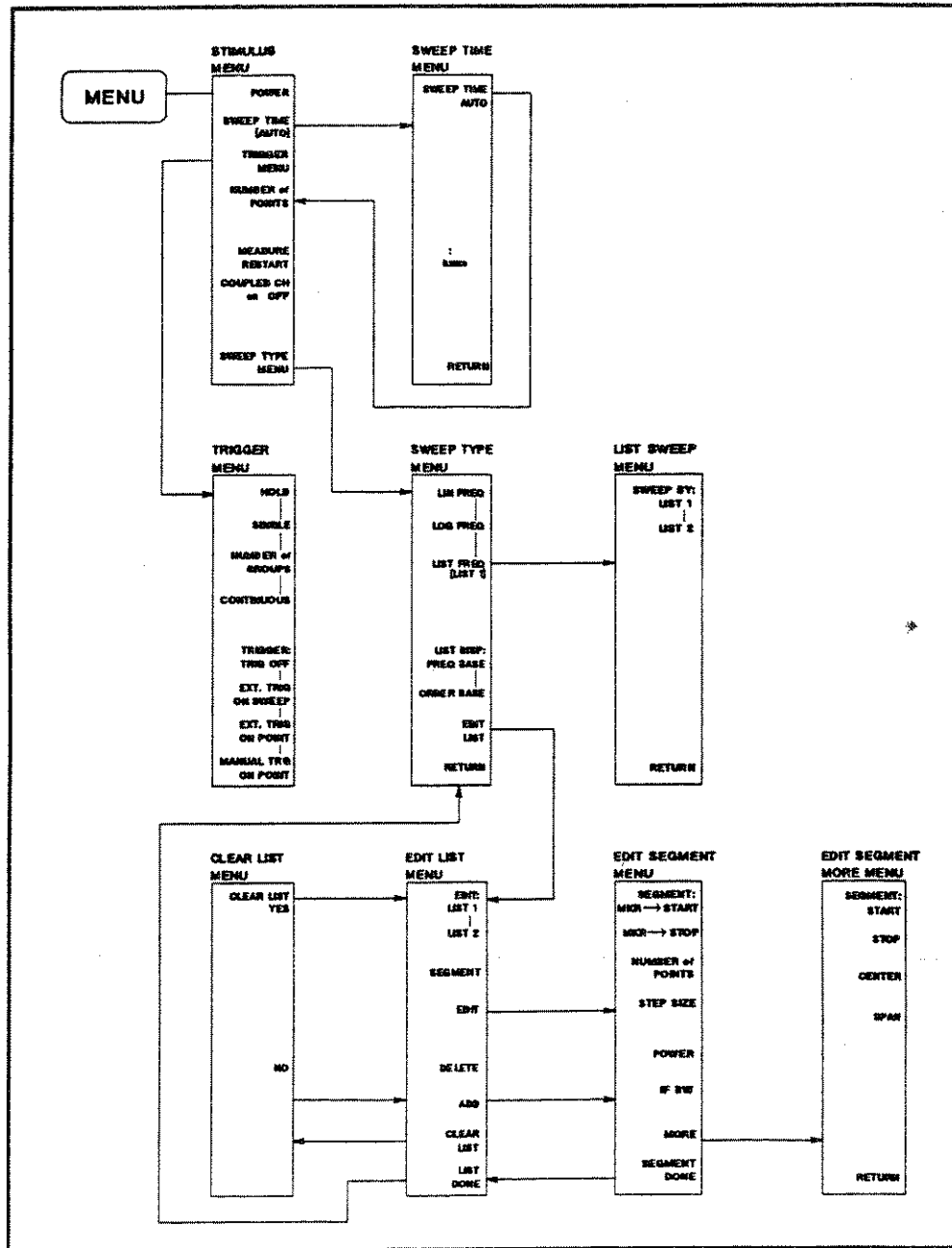

Figure 8-2. Softkey Menus Accessed from the MENU Key

The HP-IB programming command is shown in parenthesis following the key or softkey.

The **MENU** (KEY 19) key provides access to the series of menus illustrated in Figure 8-2, which define and control all stimulus functions other than Start, Stop, Center, and Span. When the **MENU** key is pressed, the stimulus menu is displayed. This in turn provides access to the other softkey menus. The functions available in these menus are described in the following paragraphs.

Stimulus Menu

The stimulus menu specifies power level, the number of measurement points per sweep. It includes the capability to couple or uncouple the stimulus functions of the two display channels, and the measurement restart function. In addition, it leads to other softkey menus that define sweep time, trigger type, and sweep type. The individual softkey functions of the stimulus menu are described below.

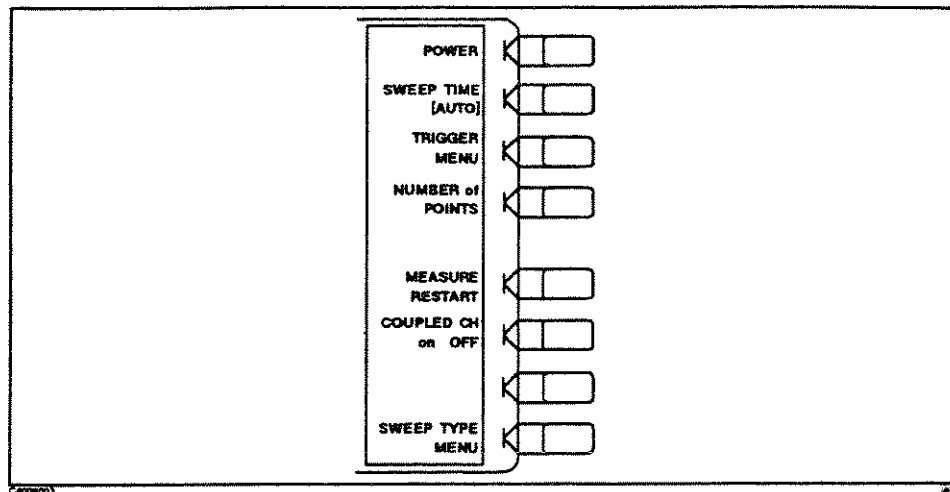

Figure 8-3. Stimulus Menu

POWER (POWE) makes power level the active function, which sets the output power level. The allowable power range is -15 dBm to $+5$ dBm.

SWEEP TIME [] (SWET) makes sweep time value the active function and presents the sweep time menu, which toggles between automatic and manual sweep time.

TRIGGER MENU presents the trigger menu, which selects the type of the sweep trigger.

NUMBER of POINTS (POIN) selects the number of data points per sweep. Using fewer points allows a faster sweep time but the displayed trace shows less horizontal detail. Using more points gives greater data density and improved trace resolution, but slows the sweep.

The possible values that can be entered for number of points are 2 through 801 with a step value of 1. The number of points can be different for the two channels if the stimulus values are uncoupled.

In list frequency sweep, the number of points displayed is the total number of frequency points for the defined list (see "Sweep Type Menu" in this chapter).

MEASURE RESTART (REST) aborts the sweep in progress, then restarts the measurement. This can update a measurement following an adjustment of the device under test.

If the analyzer is taking a number of groups (see "Trigger Menu" in this chapter), the sweep counter is reset to 1. If averaging is ON, **MEASURE RESTART** resets the sweep-to-sweep averaging and is effectively the same as **AVERAGING RESTART**.

If the sweep trigger is in the **HOLD** mode, **MEASURE RESTART** executes a single sweep. If **DUAL CHAN** is ON (screen displays both measurement channels), **MEASURE RESTART** executes a single sweep to both channels even if **COUPLED CH** is OFF.

COUPLED CH on OFF (COUCON, COUCOFF) toggles the channel coupling of stimulus values. With **COUPLED CH ON** (the preset condition), both channels have the same stimulus values (the inactive channel takes on the stimulus values of the active channel).

In the stimulus coupled mode, the following parameters are coupled:

- Frequency
- Number of points
- Source power level
- Number of groups
- IF bandwidth
- Sweep time
- Trigger type
- Sweep type
- List sweep table

If both channels have the same input parameter such as A/R and A, the following parameters are also coupled:

- Correction mode
- Calibration coefficient

The following parameters are always common to both channels, even if the stimulus mode is not coupled.

- External trigger mode
- Calibration kit type and data

The following parameters are always set separately for each channel, even if the stimulus mode is coupled.

- Measurement parameter
- Display Format
- Title (on/off)
- Scale reference value
- Electrical delay
- Phase offset
- Averaging (on/off, factor)
- Smoothing (on/off, factor)

Coupling of stimulus values for the two channels is independent of **DUAL CHAN on OFF** in the display menu and **MARKERS: UNCOUPLED** in the marker mode menu. **COUPLED CH OFF** becomes an alternate sweep function when dual channel display is ON: in this mode the analyzer alternates between the two sets of stimulus values for measurement of data and both are displayed.

SWEEP TYPE MENU presents the sweep type menu, where one of the available types of stimulus sweep can be selected.

Sweep Time Menu

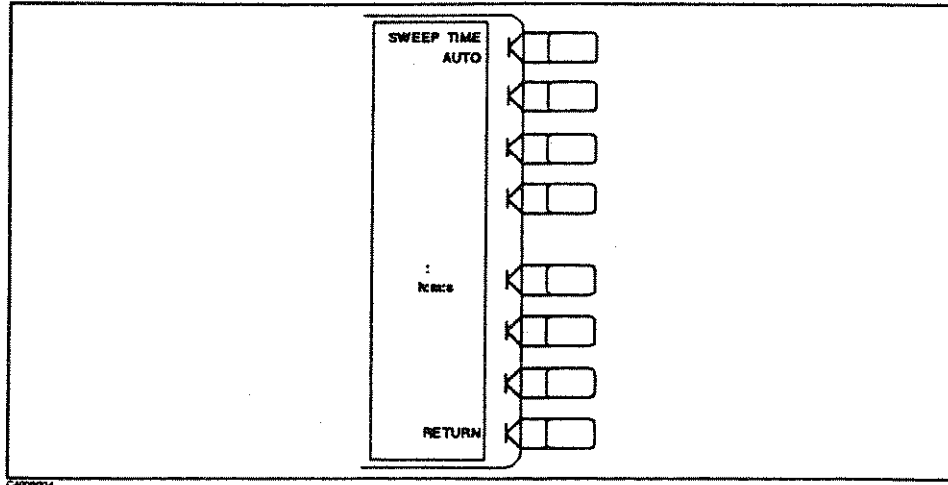

Figure 8-4. Sweep Time Menu

SWEEP TIME AUTO (SWETAUTO) selects the proper sweep time automatically. The following explains the difference between automatic and manual sweep time:

- **Manual Sweep Time.** As long as the selected sweep speed is within the capability of the instrument, it will remain fixed, regardless of changes in other measurement parameters. If the operator changes measurement parameters such that the instrument can no longer maintain the selected sweep time, the analyzer will change to the best sweep time possible. Manual mode is turned ON by entering a sweep time.
- **Auto Sweep Time.** Auto sweep time continuously maintains the fastest sweep speed possible with the selected measurement parameters to satisfy the specifications. Auto sweep time is turned ON by pressing **SWEEP TIME AUTO** (SWETAUTO) when manual sweep is ON.

Sweep time refers only to the time that the instrument is sweeping and taking data, and does not include the time required for internal processing of the data. A sweep speed indicator “↑” is displayed on the trace for sweep times slower than 1.0 second.

Minimum sweep time. The minimum sweep time depends on several factors. These factors are referred to as “measurement parameters” in the following paragraphs.

- The number of points selected
- IF bandwidth

The following table is a partial guide for determining the minimum sweep time. The typical values listed represent the minimum time required for a measurement with averaging OFF. Values are given in seconds.

Table 8-1. Minimum Sweep Time In Seconds (Typical Value)

Number Of Points	IF Bandwidth				
	8 kHz	4 kHz	1 kHz	200 Hz	20 Hz
11	2.75 m	4.4 m	11 m	37.4 m	565.4 m
51	12.75 m	20.4 m	51 m	173.4 m	2.621
101	25.25 m	40.4 m	101 m	343.4 m	5.191
201	50.25 m	80.4 m	201 m	633.4 m	10.331
401	100.25 m	160.4 m	401 m	1.363	20.611
801	200.25 m	320.4 m	801 m	2.723	41.171

: h:m:s inputs ":" for the manual sweep time entry.

RETURN goes back to the stimulus menu.

Trigger Menu

This menu selects the type of the sweep trigger.

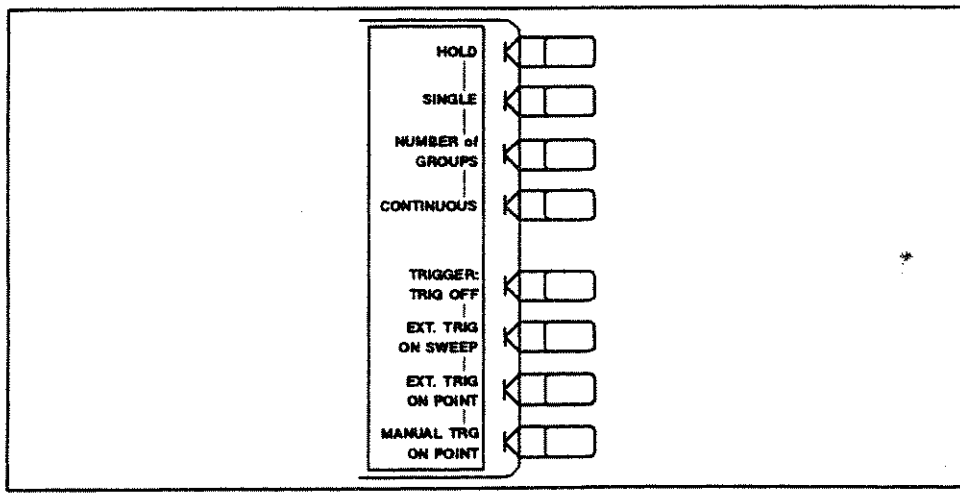

Figure 8-5. Trigger Menu

HOLD (HOLD) freezes the data trace on the display, and the analyzer stops sweeping and taking data. The notation "Hld" is displayed at the left of the graticule. If the "*" indicator is ON at the left side of the display, trigger a new sweep using **SINGLE**.

SINGLE (SING) takes one sweep of data and returns to the hold mode.

NUMBER of GROUPS (NUMG) triggers a user-specified number of sweeps, and returns to the hold mode.

If averaging is ON, the number of groups should be at least equal to the averaging factor selected to allow measurement of a fully averaged trace. Entering a number of groups resets the averaging counter to 1.

CONTINUOUS (CONT) is the standard sweep mode of the analyzer, in which the sweep is triggered automatically and continuously and the trace is updated with each sweep.

TRIGGER: TRIG OFF (EXTTOFF) turns OFF the external trigger mode.

EXT. TRIG ON SWEEP (EXTTON) is used when the sweep is triggered on an externally generated signal input through the rear panel EXT TRIGGER input. The sweep is started with a low-to-high transition of a TTL signal. If this key is pressed when no external trigger signal is connected, the notation "Ext" is displayed at the left side of the display to indicate that the analyzer is waiting to be triggered. When a trigger signal is connected, the "Ext" notation is replaced by the sweep speed indicator "↑" either in the status notations area or on the trace. External trigger mode is allowed in every sweep mode.

EXT. TRIG ON POINT (EXTTPOIN) is similar to the trigger on sweep, but triggers each data point in a sweep.

MANUAL TRG ON POINT (MANTRIG) waits for a manual trigger for each point. Subsequent pressing of this softkey triggers each measurement. The annotation "man" will appear at the left side of the display when the instrument is waiting for the trigger to occur.

Sweep Type Menu

Three sweep types are available:

- Linear frequency sweeps
- Logarithmic frequency sweeps
- List frequency sweep. Two independent lists are available.

Interpolated Error Correction. The interpolated error correction feature functions with all sweep types.

Interpolated error correction automatically turns ON when the stimulus parameters are changed after measuring calibration data. See Chapter 10 for more information on interpolated error correction.

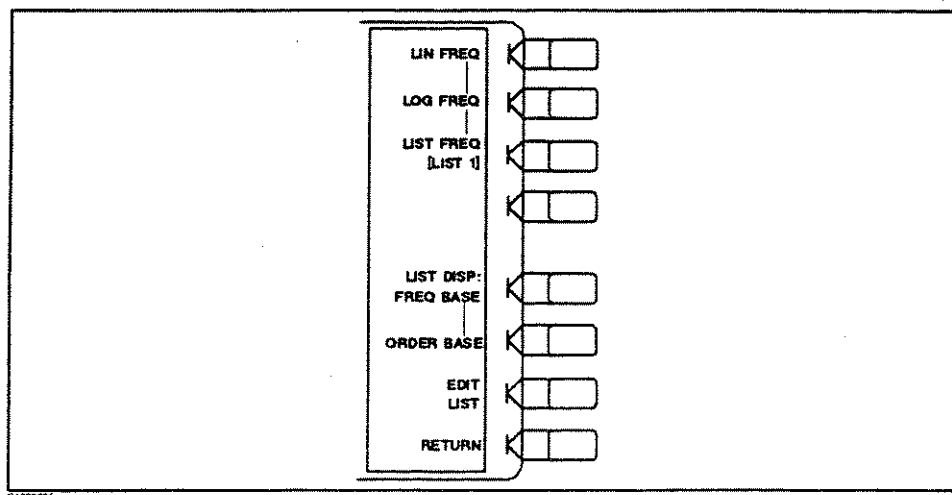

Figure 8-6. Sweep Type Menu

LIN FREQ (LINFREQ) activates a linear frequency sweep mode. The data is displayed on a standard graticule with ten equal horizontal divisions. This is the default preset sweep type.

LOG FREQ (LOGFREQ) activates a logarithmic frequency sweep mode. The source is stepped in logarithmic increments and the data is displayed on a logarithmic graticule.

LIST FREQ [LIST 1] or **LIST FREQ [LIST 2]** (LISFREQ) shows the active list number and activates the frequency list mode, and presents the "List Sweep Menu" if two frequency lists have been defined.

Frequency list mode allows you to measure DUT response over several distinct frequency ranges or at specific frequency points. Each entry in the frequency list is called a *SEGMENT*, regardless of it being a frequency range or single point. Each segment can specify the number of points, source power level, and IF bandwidth. Up to 31 segments can be specified in any combination in one of two independent lists.

Before using frequency list mode, the frequency list must be created. See "Edit List Menu", "Edit Segment Menu", and "Edit Segment More Menu" later in this chapter for entering and modifying the lists.

A tabular printout of the frequency list data can be obtained using the **LIST SWEEP TABLE** function in the copy more menu.

LIST DISP: FREQ BASE (LISDFBASE) displays data measured as frequency base in the frequency list mode. The frequency scale is linear across the total range. Since the frequency points may not distribute evenly across the graticule, the display resolution may be uneven, and more compressed in some parts of the trace than in others.

ORDER BASE (LISDOBASE) displays data measured as order base in the frequency list mode. The displayed frequency resolution is even across the graticule, even though the frequency points are not distributed evenly.

EDIT LIST (EDITLIST) presents the edit list menu. This is used in conjunction with the edit segment menu to define or modify the frequency sweep list. The list frequency sweep mode is selected with the **LIST FREQ [LIST 1]** or **LIST FREQ [LIST 2]** softkey described above.

RETURN goes back to the stimulus menu.

List Sweep Menu

This menu activates one of the frequency lists to be swept. If there is only one list, or no list is defined, the menu will not be provided.

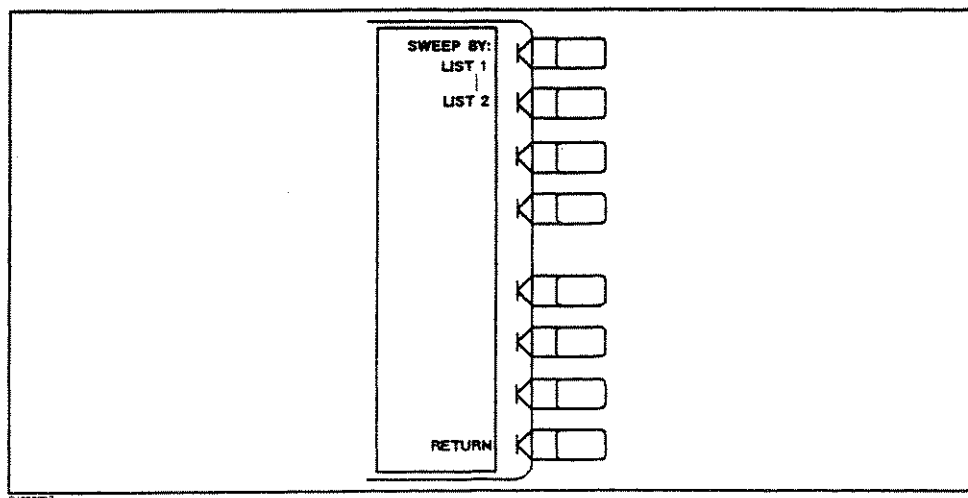

Figure 8-7. List Sweep Menu

SWEEP by:LIST 1 (LISSLIS1) activates LIST 1 for the list sweep.

LIST 2 (LISSLIS2) activates LIST 2 for the list sweep.

RETURN goes back to the sweep type menu without any change.

Edit List Menu

This menu edits the list of frequency segments (subsweep) defined with three other menus. Each of two lists can specify up to 31 frequency segments, for a maximum of 801 points. The segments do not have to be entered in any particular order: the analyzer automatically sorts them and lists them on the display in increasing order of start frequency. This menu determines which segment on the list is to be modified, while other menus change the frequency range, number of points, power level and IF bandwidth of the selected segment.

Note



The list and segment data are cleared on instrument preset, cycling the power and instrument state recall. The list and segment data can be saved with the built-in Flexible disk drive and the RAM disk memory. (See Chapter 14).

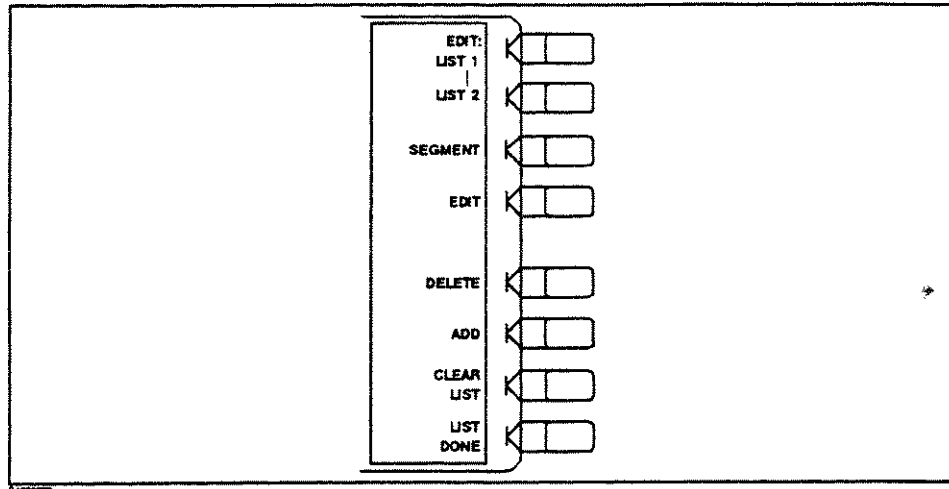

Figure 8-8. Edit List Menu

EDIT:LIST 1 (EDITLIS1) selects LIST 1 to edit.

LIST 2 (EDITLIS2) selects LIST 2 to edit.

SEGMENT (SEDI) determines a segment on the list to be modified. Enter the number of a segment in the list, or use the step keys to scroll the pointer ">" at the left to the required segment number. The indicated segment can then be edited or deleted.

EDIT provides the edit segment menu, where the segment indicated by the pointer ">" at the left can be modified.

DELETE (SDEL) deletes the segment indicated by the pointer ">".

ADD (SADD) adds a new segment to be defined with the edit segment menu. If the list is empty, a default segment is added, and the edit segment menu is displayed so it can be modified. If the list is not empty, the segment indicated by the pointer ">" is copied and the edit segment menu is displayed.

CLEAR LIST (CLEL) provides the clear list menu.

LIST DONE (EDITDONE) sorts the frequency points and returns to the sweep type menu.

Edit Segment Menu

This menu is used to select arbitrary measurement frequencies. Using this menu it is possible to define the exact frequencies to be measured on a point-by-point basis. For example the sweep could include 100 points in a narrow pass-band, 100 points across a broad stop band, and 50 points across the third harmonic response. The total sweep is defined with a list of segments (subsweeps). Up to 31 segments can be defined, with a total of up to 801 data points.

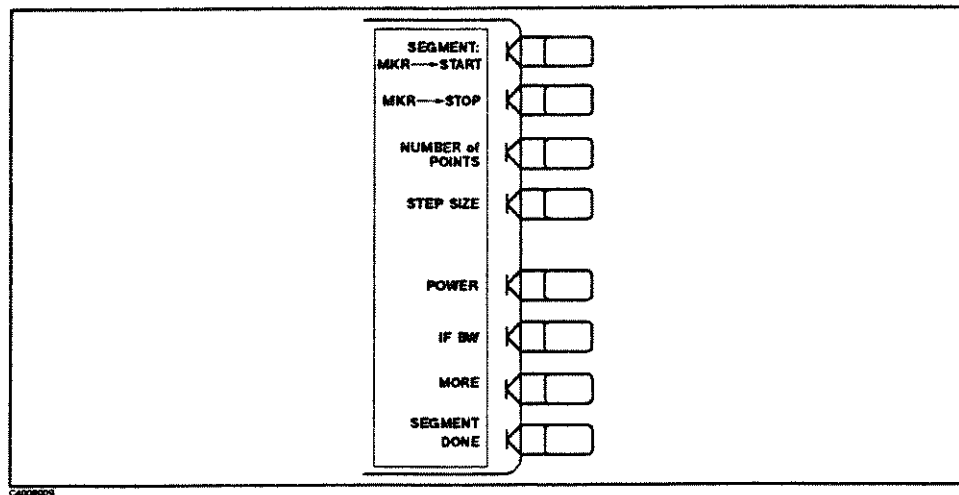

Figure 8-9. Edit Segment Menu

The frequency segments, or segments, can be defined in any of the following terms:

- Start / stop / number of points
- Start / stop / step
- Center / span / number of points
- Center / span / step

The segments can overlap, and do not have to be entered in any particular order. The analyzer sorts the segments automatically and lists them on the display in order of increasing start frequency, regardless of the order in which they are entered. If duplicate frequencies exist, the analyzer makes multiple measurements on identical points to maintain the specified number of points for each segment. The data is displayed as a single trace that is a composite of all data taken when the list display function is frequency base.

The list frequency sweep mode is selected with the **LIST FREQ** softkey in the sweep type menu.

The frequency list parameters can be saved with the built-in floppy disk and the RAM disk memory. (See Chapter 14.)

Note



Not only the softkeys described below, use also the **START**, **STOP**, **CENTER**, and **SPAN** keys to define the stimulus range.

MKR → START (MARKSTAR) sets the stimulus start value to the stimulus value of the active marker.

MKR → STOP (MARKSTOP) sets the stimulus stop value to the stimulus value of the active marker.

NUMBER of POINTS (POINT) sets the number of points for the segment. The total number of points for all the segments cannot exceed 801.

STEP SIZE (STPSIZE) specifies the segment in frequency steps instead of number of points. Changing the start frequency, stop frequency, span, or number of points may change the step size. Changing the step size may change the number of points and stop frequency in start/stop/step mode; or the frequency span in center/span/step mode. In each case, the frequency span becomes a multiple of the step size.

SEGMENT POWER (POWE) sets power level for segment by segment. The allowable range is -15 dBm to +5 dBm.

IF BW (IFBW) sets IF bandwidth for segment by segment. The allowable bandwidths are 20, 200, 1 k, 4 kHz, and 8 kHz.

MORE goes to the edit segment more menu, which allows the stimulus range values to be entered using the Entry keys, Start, Stop, Center, and Span.

SEGMENT DONE (SDON) returns to the edit list menu.

Edit Segment More Menu

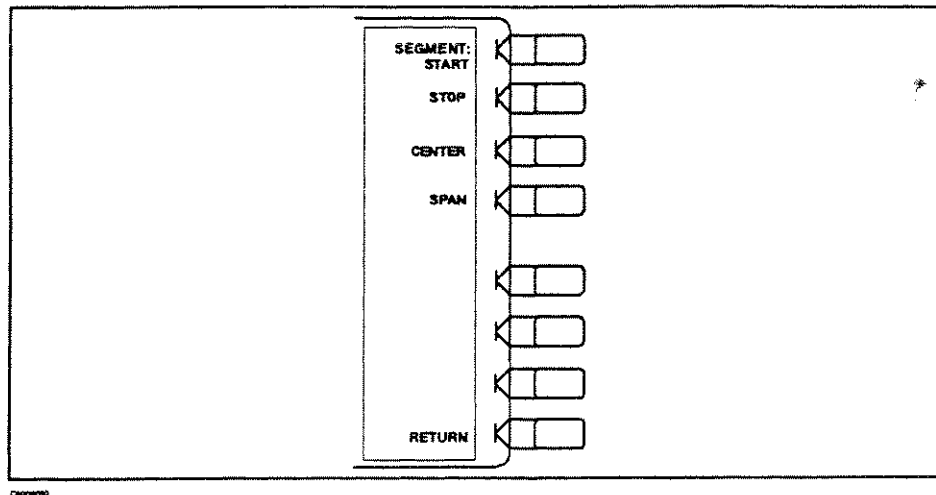

Figure 8-10. Edit Segment More Menu

SEGMENT START (STAR) sets the START frequency of a segment.

STOP (STOP) sets the STOP frequency of a segment.

CENTER (CENT) sets the CENTER frequency of a segment.

SPAN (SPAN) sets the frequency SPAN of a segment about a specified center frequency.

RETURN goes back to the edit segment menu.

Clear List Menu

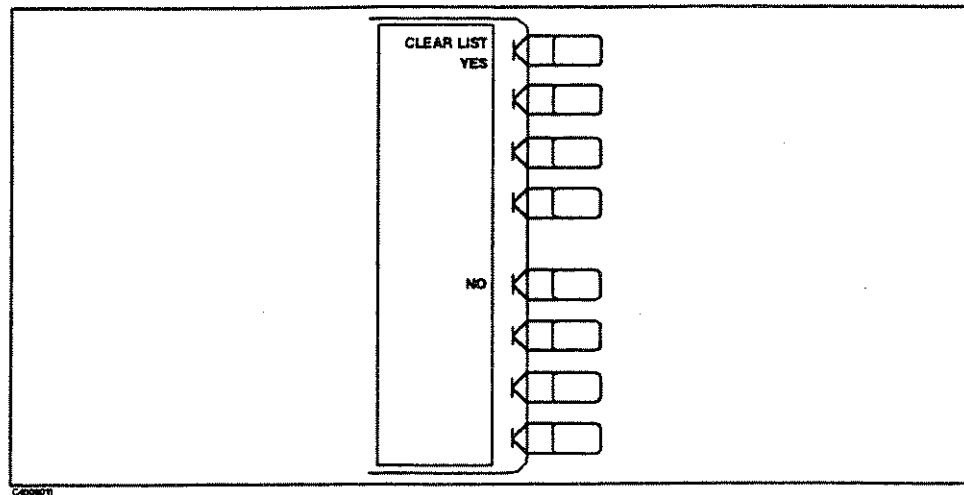

Figure 8-11. Clear List Menu

CLEAR LIST YES (CLEL) clears the entire list.

NO cancels and goes back to the edit list menu.

Response Function Block

Introduction

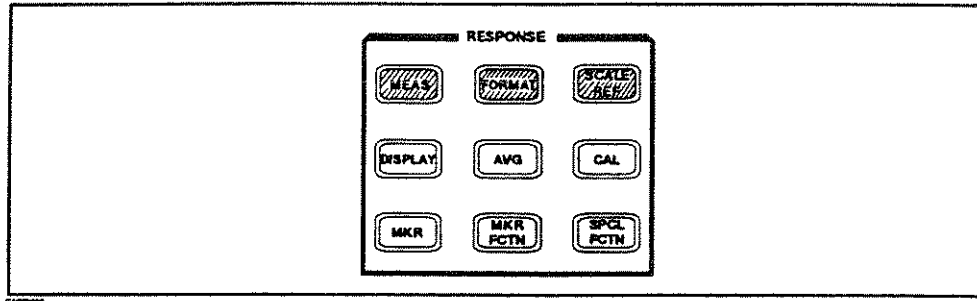

Figure 9-1. Response Function Block

The keys in the *RESPONSE* block control the measurement and display functions of the active channel. They provide access to many different softkey menus that offer selections for the measuring parameters, the display mode and data format, the control of the display markers, a variety of calibration functions, and some wave form analysis functions.

The HP-IB programming command is shown in parenthesis following the key or softkey.

The current values for the major response functions of the active channel are displayed in specific locations along the top of the display. In addition, certain functions accessed through the keys in this block are annotated in the status notations area at the left side of the display. The locations of these information labels are described in Chapter 5.

The *RESPONSE* block keys and their associated menus are described briefly below, and in more detail in this and the following chapters.

The **(MEAS)** key provides access to a series of softkey menus for selecting the parameters or inputs to be measured.

The **(FORMAT)** key leads to a menu which selects the display format for the data. Various rectangular and polar formats are available for display of magnitude, phase, impedance, group delay, real data, and imaginary data.

The **(SCALE REF)** key displays a menu which modifies the vertical axis scale and the reference line value as well as electrical length and phase offset.

The **(DISPLAY)** key leads to a series of menus for instrument and active channel display functions. This menu include dual channel display (overlaid or split), active channel display title, trace display ON/OFF, graticule display ON/OFF, and frequency blanking.

The **(AVG)** key accesses three different noise reduction techniques: sweep-to-sweep averaging, trace smoothing, group delay aperture, and variable IF bandwidth.

The **(SPCL FCTN)** key provides the special function menu, that quickly gets certain measurement parameters without going through the usual key sequence.

The **CAL** key, **MKR** and **MKR FCTN** keys are explained later. For information on **CAL**, see Chapter 10. For information on **MKR**, and **MKR FCTN**, see Chapter 11.

MEAS Key

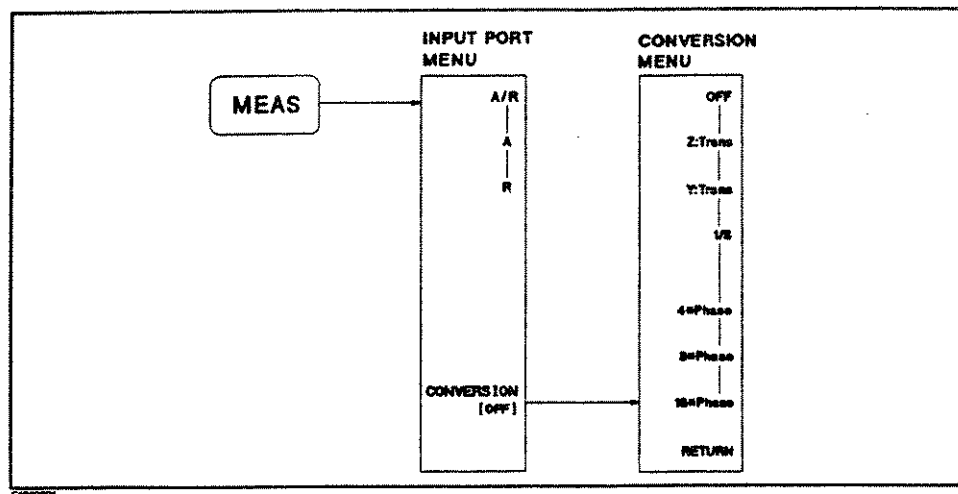

Figure 9-2. Softkey Menus Accessed from the **MEAS** Key

The HP-IB programming command is shown in parenthesis following the key or softkey.

The **MEAS** key leads to a series of softkey menus from which the parameters and measurement inputs are specified.

- Alternatively, the power ratio of two inputs (A/R) or the absolute power at either input can be measured and the results displayed.
- Using the HP 87510A's internal math capabilities, transmission characteristics can be converted to impedance (Z), admittance (Y), or inverse data (R/A, 1/A, and 1/R).
- The math capabilities allow multiplying phase data by a factor of 4, 8, or 16.

Input Ports Menu

The input ports menu is presented when the **MEAS** key is pressed if there is no S-parameter test set connected and two-port error correction is not ON. This menu defines the input ports for power ratio measurements, or a single input for magnitude only measurements of absolute power.

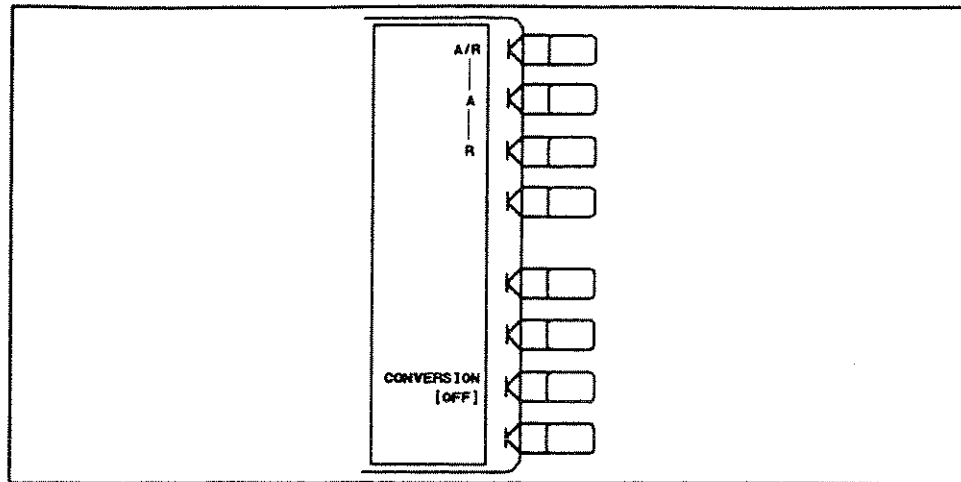

Figure 9-3. Input Ports Menu

A/R (AR) calculates and displays the complex ratio of the signal at input A to the reference signal at input R.

A (MEASA) measures the absolute power amplitude at input A.

R (MEASR) measures the absolute power amplitude at input R.

CONVERSION presents the conversion menu, which converts the measured data to impedance (Z) admittance (Y) or inverse data (R/A, 1/A, and 1/R). When a conversion parameter has been defined, it is shown in brackets under the softkey label. If no conversion has been defined, the softkey label reads **CONVERSION OFF**.

Conversion Menu

This menu converts the measured transmission data to the equivalent complex impedance (Z) or admittance (Y) values. This is not the same as a two-port Y or Z parameter conversion, as only the measured parameter is used in the following equations.

In a transmission measurement, the data can be converted to its equivalent series impedance or admittance using the model and equations shown in Figure 9-4.

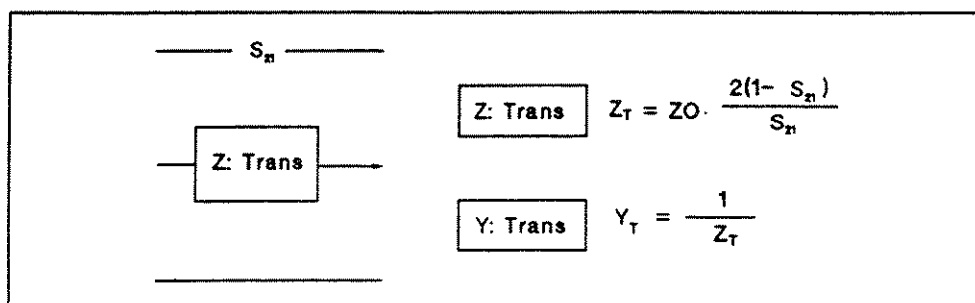

Figure 9-4. Transmission Impedance and Admittance Conversions

Avoid using delay formats for displaying Z and Y conversions, as these formats are not easily interpreted.

In Z and Y conversions, marker values are impedance values in Ω units for Z conversions, or admittance values in S units for Y conversions in any format.

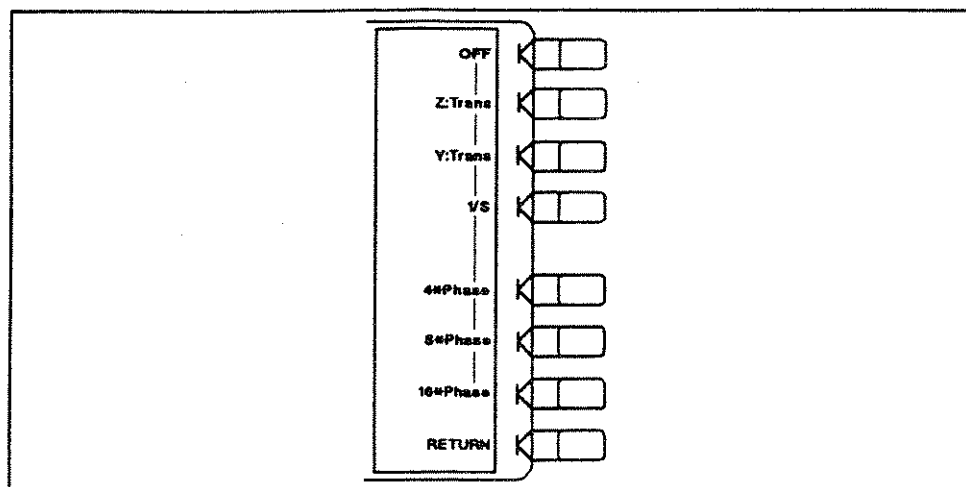

Figure 9-5. Conversion Menu

OFF (CONVOFF) turns OFF all parameter conversion operations.

Z: Trans (CONVZTRA) converts transmission data to its equivalent impedance values.

Y: Trans (CONVYTRA) converts transmission data to its equivalent admittance values.

1/S (CONV1DS) expresses the data in inverse S-parameter values, for use in amplifier and oscillator design.

4*phase (CONVMP4) multiplies phase data by a factor of 4.

8*phase (CONVMP8) multiplies phase data by a factor of 8.

16*phase (CONVMP16) multiplies phase data by a factor of 16.

RETURN returns to the input ports menu.

FORMAT Key

The HP-IB programming command is shown in parenthesis following the key or softkey.

Format Menu

The **FORMAT** key presents a menu used to select the appropriate display format for the measured data. Various rectangular and polar formats are available for display of magnitude, phase, real data, imaginary data, and group delay. The units of measurement are changed automatically to correspond with the displayed format. Special marker menus are available for the polar format, each providing several different marker types for readout of values (see Chapter 11).

The illustrations below show a reflection measurement of a bandpass filter displayed in each of the available formats.

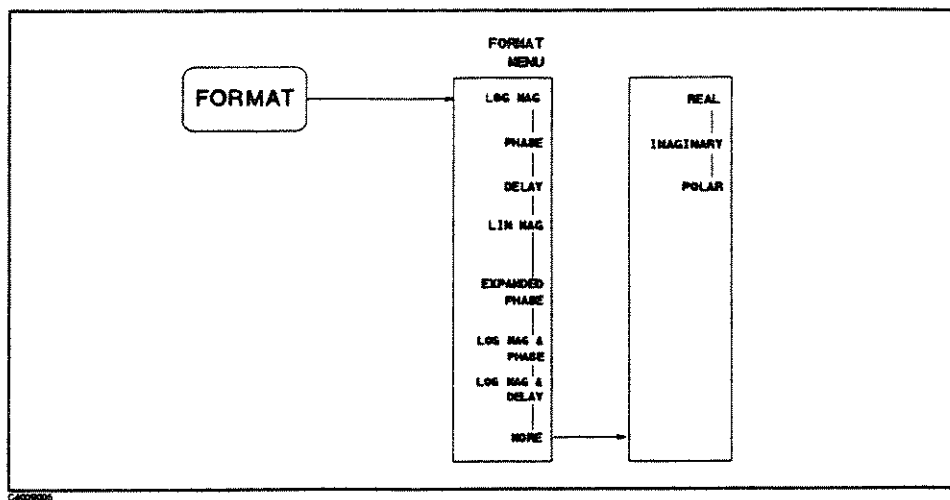

Figure 9-6. Format and Format More Menus

LOG MAG (LOGM) displays the log magnitude format. This is the standard Cartesian format used to display magnitude-only measurements of insertion loss, or absolute power in dB versus frequency. Figure 9-7 illustrates the bandpass filter transmission data in a log magnitude format.

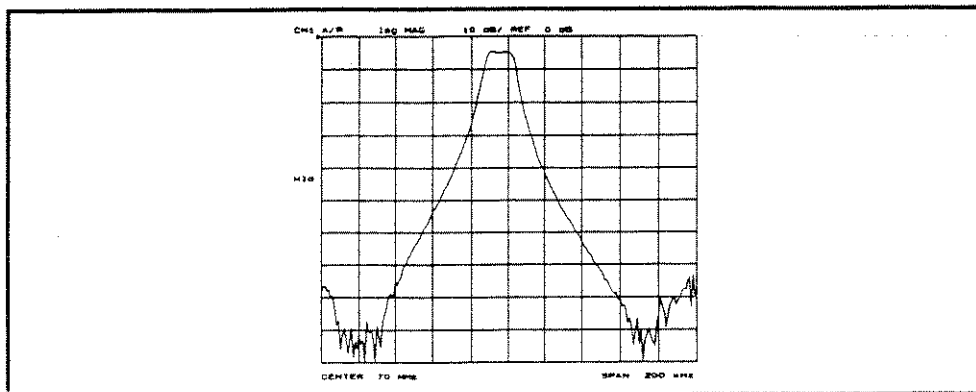

Figure 9-7. Log Magnitude Format

PHASE (PHAS) displays a Cartesian format of the phase portion of the data, measured in degrees. This format displays the phase shift versus frequency. Figure 9-8 illustrates the phase response of the same filter in a phase-only format.

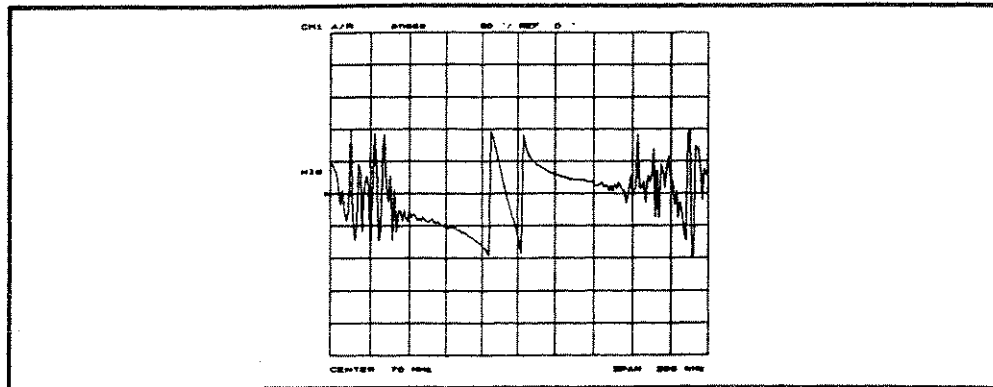

Figure 9-8. Phase Format

DELAY (DELA) selects the group delay format. Activated markers give values in seconds. Figure 9-9 shows the bandpass filter response formatted as group delay. When power sweep is selected, this selects the delay format using delta power instead of frequency. Group delay principles are described in the next few pages.

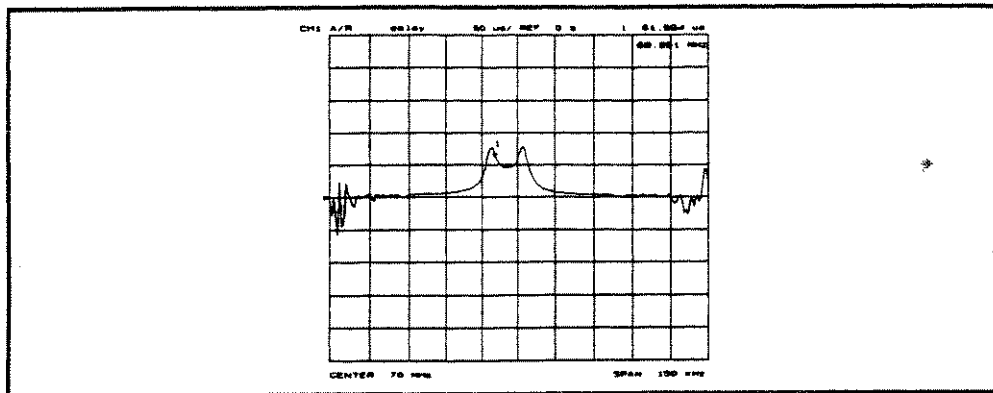

Figure 9-9. Group Delay Format

LIN MAG (LINM) displays the linear magnitude format (Figure 9-10). This is a Cartesian format used for unitless measurements such as reflection coefficient magnitude ρ or transmission coefficient magnitude τ , and for linear measurement units. It is used for display of conversion parameters.

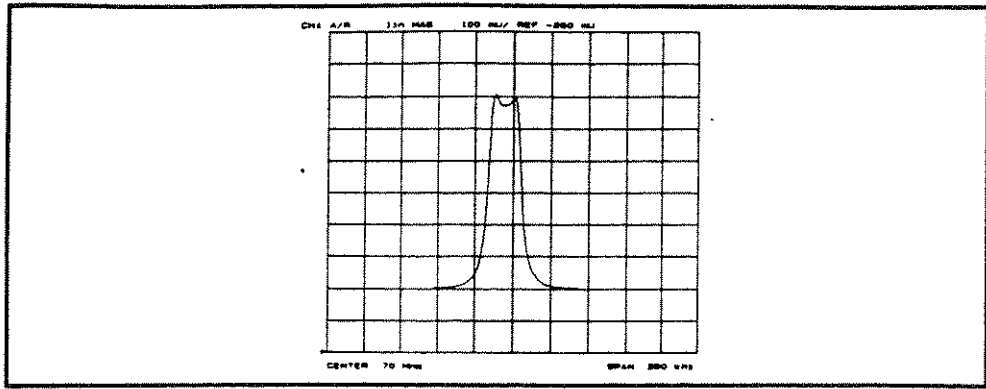

Figure 9-10. Linear Magnitude Format

EXPANDED PHASE (EXPP) displays the phase plot over 360°(Figure 9-11). When this is turned ON, the analyzer avoids the phase plot wrap around every 360°.

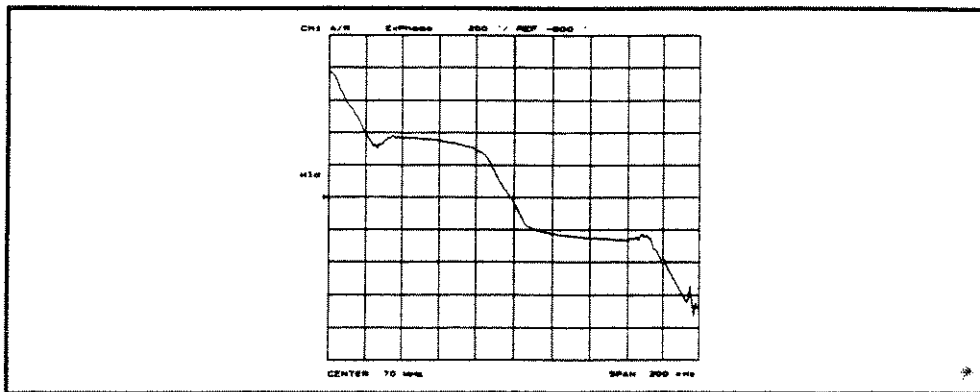

Figure 9-11. Expanded phase Format

LOG MAG & PHASE (LOGMP) displays log magnitude trace and phase trace for the active channel simultaneously. When this softkey is turned ON, some other softkeys will denote the log magnitude and the phase as "DATA" (data trace) and "SUB-TRACE" (sub trace), respectively.

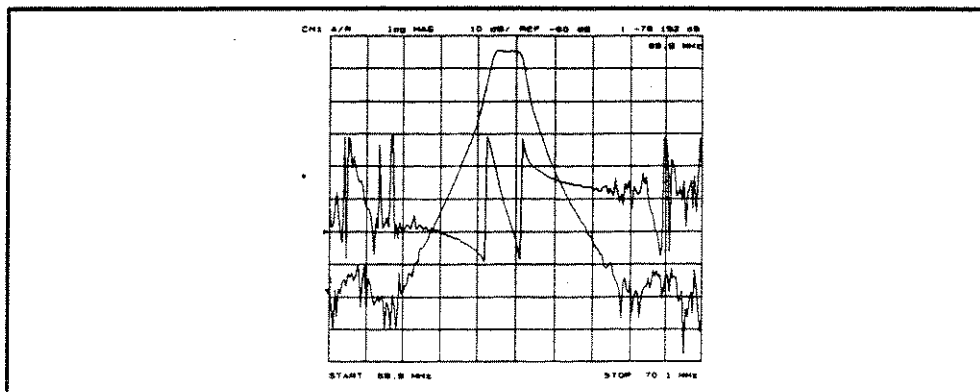

Figure 9-12. Log Magnitude and Phase Format

LOG MAG & DELAY (LOGMD) displays log magnitude trace and delay trace for the active channel simultaneously. When this softkey is turned ON, some other softkeys will denote the log magnitude trace and the delay as "DATA" (data trace) and "SUB" (sub trace), respectively.

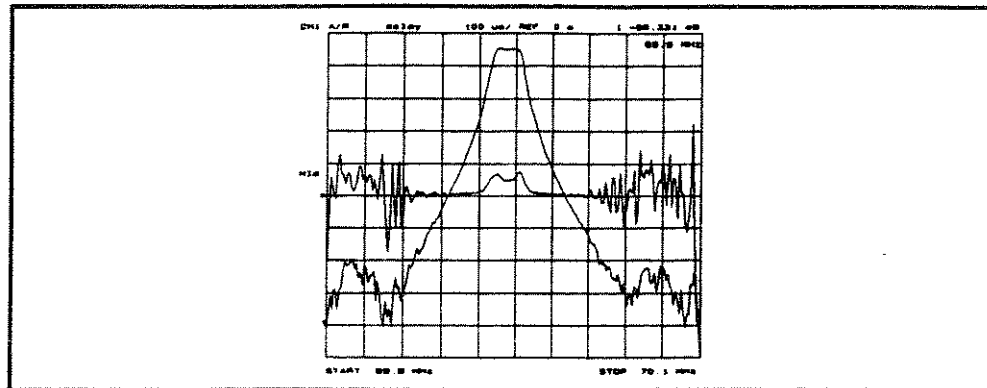

Figure 9-13. Log magnitude and Delay Format

MORE provides the format more menu described in the next section.

Format More Menu

This menu provides two additional formatting selections.

REAL (REAL) displays only the real (resistive) portion of the measurement data in Cartesian format (Figure 9-14). This is similar to the linear magnitude format, but can show both positive and negative values.

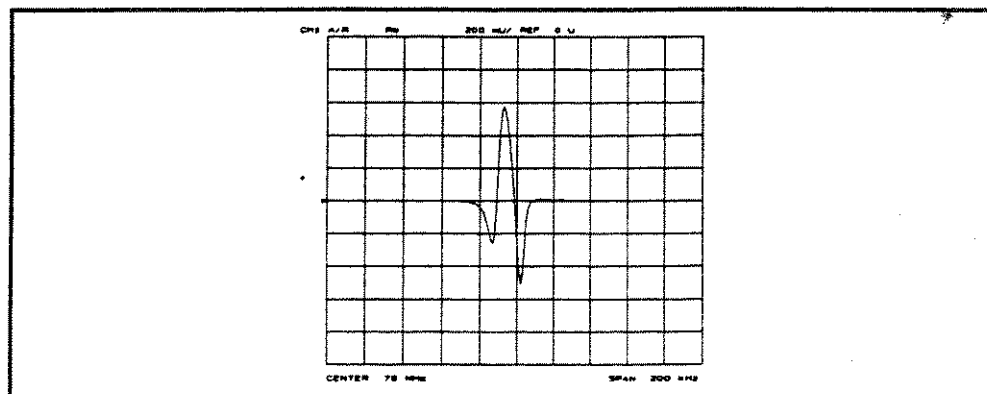

Figure 9-14. Real Format

IMAGINARY (IMAG) displays only the imaginary (reactive) portion of the measurement data in Cartesian format. This format is similar to the real format except that reactance data is displayed on the trace instead of impedance data.

POLAR (POLA) displays a polar format (Figure 9-15). Each point on the polar format corresponds to a particular value of both magnitude and phase. Quantities are read vectorally: the magnitude at any point is determined by its displacement from the center (which has zero value), and the phase by the angle counterclockwise from the positive x-axis. Magnitude is scaled in a linear fashion, with the value of the outer circle usually set to a ratio value of 1. Since there is no frequency axis, frequency information is read from the markers.

The default marker readout for the polar format is in linear magnitude and phase. A log magnitude marker and a real/imaginary marker are available in the polar marker menu (see Chapter 11).

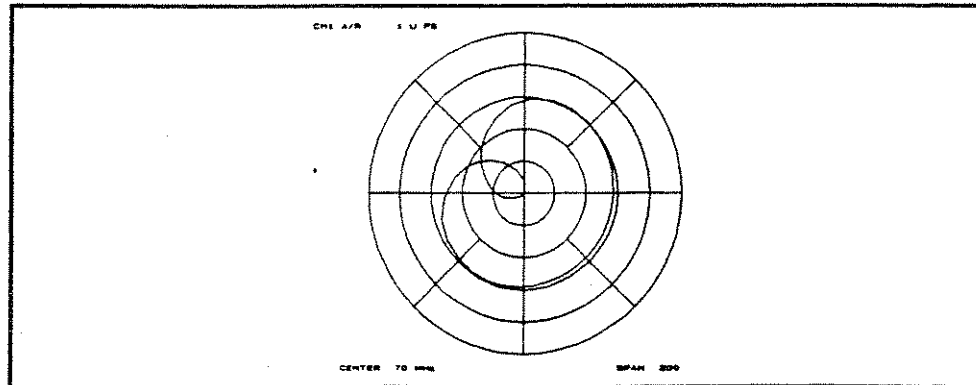

Figure 9-15. Polar Format

RETURN goes back to the format menu.

Group Delay Principles

For many gain and phase measurements, the amount of insertion phase is not as important as the linearity of the phase shift over a range of frequencies.

The analyzer can measure this linearity and express it in two different ways: directly, as deviation from linear phase, or as group delay, a derived value. See **SCALE REF** key description in this chapter for information on deviation from linear phase.

Group delay is the measurement of signal transmission time through a test device. It is defined as the derivative of the phase characteristic with respect to frequency. Since the derivative is basically the instantaneous slope (or rate of change of phase with frequency), a perfectly linear phase shift results in a constant slope, and therefore a constant group delay (Figure 9-16).

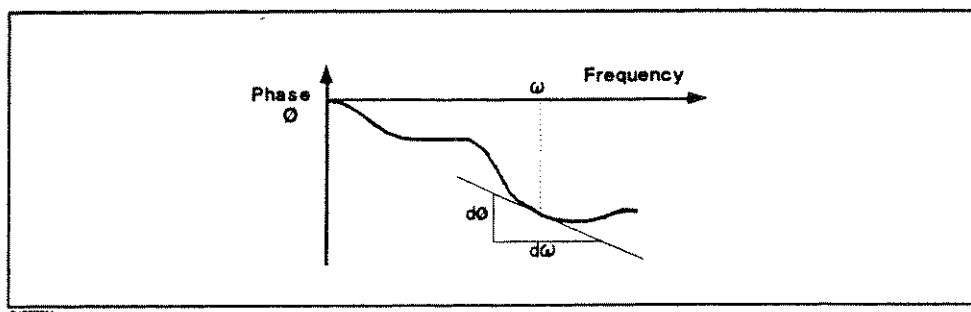

Figure 9-16. Constant Group Delay

Note, however, that the phase characteristic typically consists of both linear (first order) and higher order (deviations from linear) components. The linear component can be attributed to the electrical length of the test device, and represents the average signal transit time. The

higher order components are interpreted as variations in transit time for different frequencies, and represent a source of signal distortion (Figure 9-17).

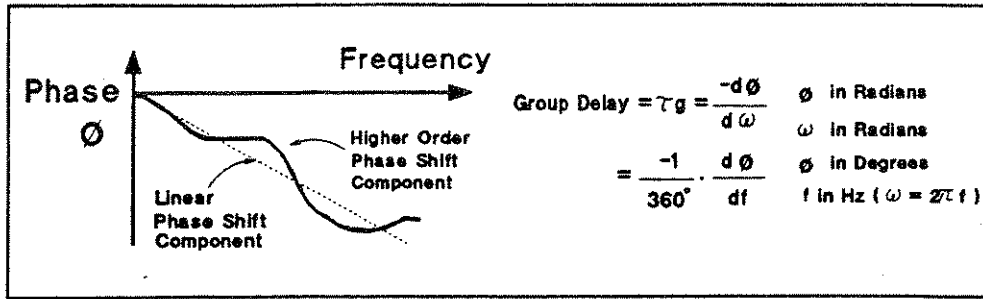

Figure 9-17. Higher Order Phase Shift

The analyzer computes group delay from the phase slope. Phase data is used to find the phase deviation, $\Delta\phi$, at the center point of a specified frequency aperture, Δf , to obtain an approximation for the rate of change of phase with frequency (Figure 9-18). This value, τ_g , represents the group delay in seconds assuming linear phase change over Δf .

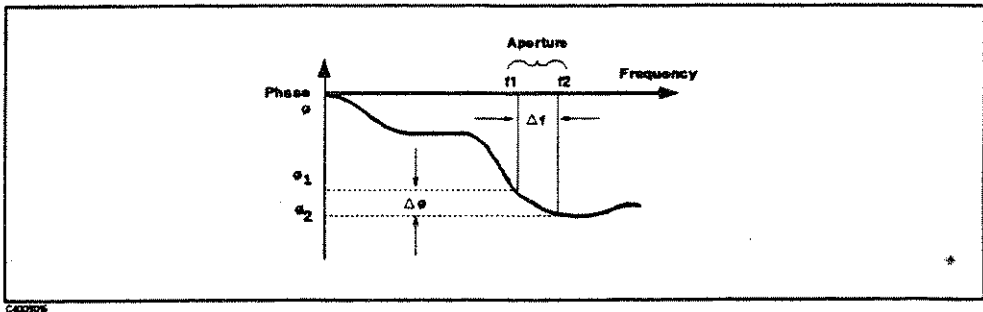

Figure 9-18. Rate of Phase Change Versus Frequency

When deviations from linear phase are present, changing the frequency step can result in different values for group delay. Note that in this case the computed slope varies as the aperture Δf is increased (Figure 9-19). A wider aperture results in loss of the fine variations in group delay. This loss of detail is the reason that in any comparison of group delay data it is important to know the aperture used to make the measurement.

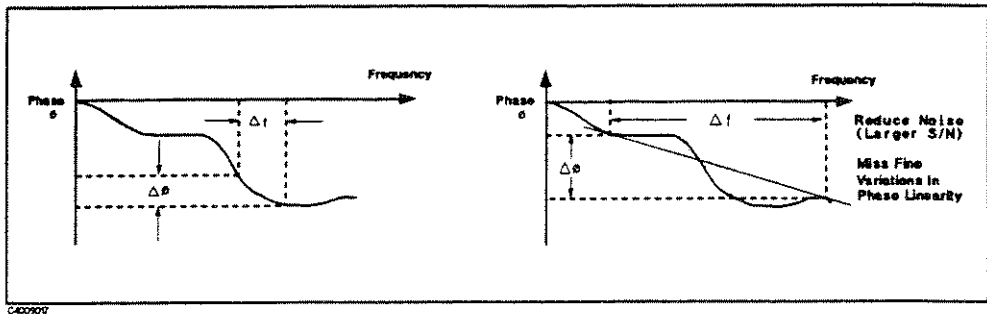

Figure 9-19. Variations in Frequency Aperture

In determining the group delay aperture, there is a tradeoff between resolution of fine detail and the effects of noise. Noise can be reduced by increasing the aperture, but this will tend to smooth out the fine detail. More detail will become visible as the aperture is decreased, but the noise will also increase, possibly to the point of obscuring the detail. A good practice is to use a smaller aperture to assure that small variations are not missed, then increase the aperture to smooth the trace.

The group delay aperture value will be a percent of the stimulus span swept which is based on the number of points. For example, the default value of 1% means that a group delay at a certain point is calculated using adjacent measurement points on both sides, if the number of points is 201.

Group delay measurements can be made on all sweep types. Group delay aperture varies depending on the frequency spacing and point density, therefore the aperture is not constant in log and list frequency sweep modes.

To obtain a readout of aperture values at different points on the trace, move the marker to a desired point. Then press **(AVG) GROUP DELY APERTURE**. Group delay aperture becomes the active function, and as the aperture is varied its value in Hz is displayed below the active entry area.

(SCALE REF) Key

The HP-IB programming command is shown in parenthesis following the key or softkey.

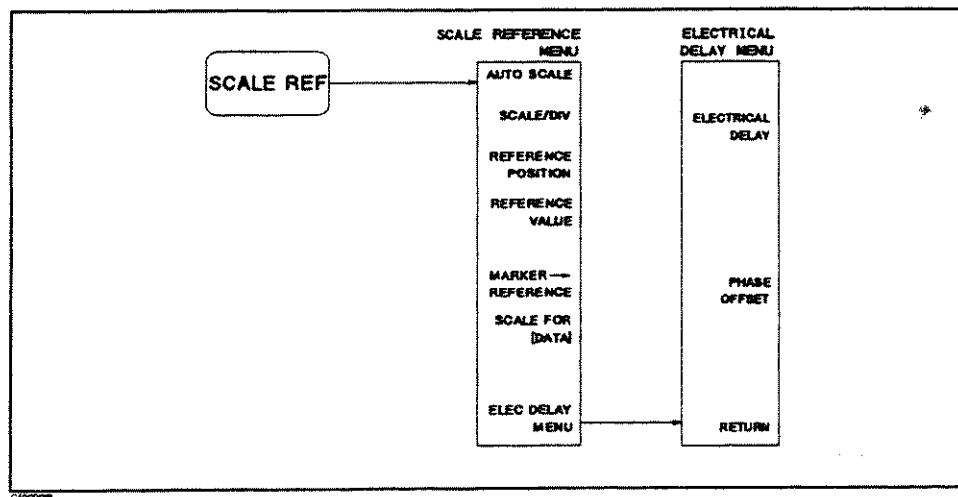

Figure 9-20. Softkey Menus Accessed from the **(SCALE REF) Key**

Scale Reference Menu

The **(SCALE REF)** key makes scale per division the active function. A menu is displayed that modifies the vertical axis scale and the reference line value and position. In addition this menu provides phase offset capabilities for adding or subtracting a phase offset, that is constant with frequency, and electrical delay capability for adding or subtracting linear phase to maintain phase linearity.

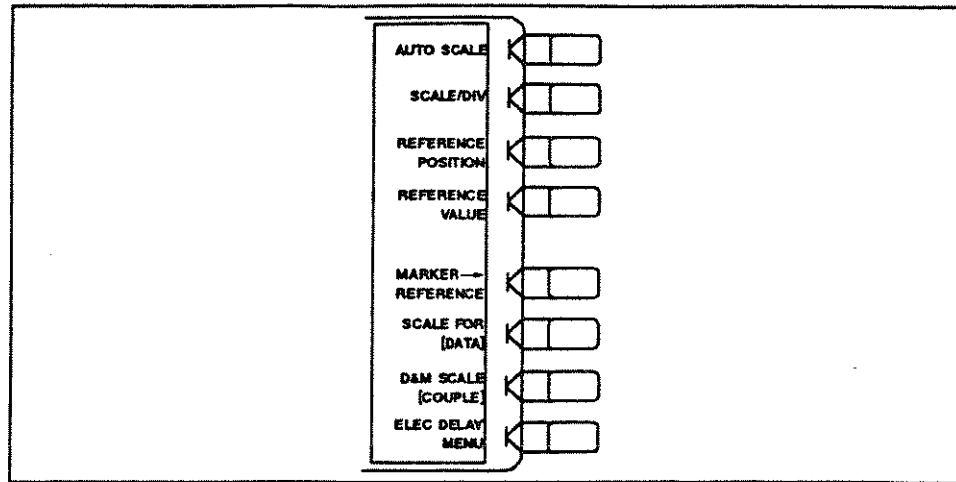

Figure 9-21. Scale Reference Menu

AUTO SCALE (AUTO) brings the trace data, defined by the **SCALE FOR** key, in view on the display with a single keystroke. Stimulus values are not affected, only the scale and reference values. The analyzer determines the smallest possible scale factor that will put all displayed data onto the vertical graticule. The reference value is chosen to put the trace in the center of the screen, then rounded to an integer multiple of 1-2-5 steps of the scale factor.

SCALE/DIV (SCAL) changes the response value scale per division of the displayed trace. In polar chart format, this refers to the full scale value at the outer circumference, and is identical to the reference value.

REFERENCE POSITION (REFP) sets the position of the reference line on the graticule of a Cartesian display, with 0 at the bottom line of the graticule and 10 at the top line. It has no effect on a polar display. The reference position is indicated with a small triangle just outside the graticule, on the left.

REFERENCE VALUE (REFV) changes the value of the reference line, moving the measurement trace correspondingly. In polar chart format, the reference value is the same as the scale, and is the value of the outer circle.

MARKER → REFERENCE (MARKREF) makes the reference value equal to the active marker's absolute value (regardless of the delta marker value). The marker is effectively moved to the reference line position. This softkey also appears in the marker function menu accessed from the **(MKR FCTN)** key. In polar chart format, this function makes the full scale value at the outer circle equal to the active marker response value.

SCALE FOR (SCAFDATA for the data trace, SCAFMEMO for the sub trace) selects one of "DATA" and "SUB" traces to be scaled by prior functions in this menu when the format is selected "LOG MAG & PHASE" and "LOG MAG & DELAY". When "LOG MAG & PHASE" format is selected, **SCALE FOR** selects one of "LOG MAG" and "PHASE" to be scaled. When "LOG MAG & DELAY" format is selected, **SCALE FOR** selects one of "LOG MAG" and "DELAY" to be scaled.

The "LOG MAG & PHASE" and "LOG MAG & DELAY" format will be available using the "Format More menu" accessed from the **(FORMAT)** key.

ELEC DELAY MENU provides "Electrical Delay Menu", which adds or subtracts a linear phase slope relative to frequency or a constant phase.

Electrical Delay Menu

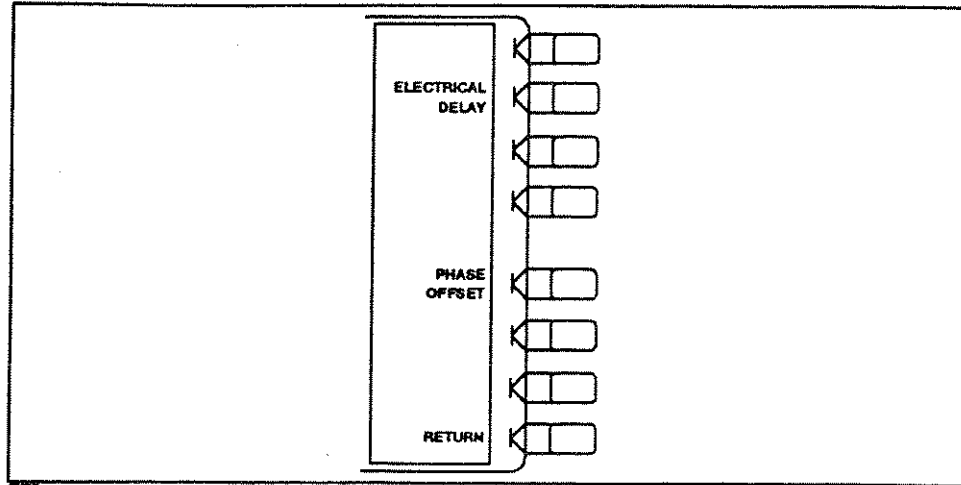

Figure 9-22. Electrical Delay Menu

ELECTRICAL DELAY (ELED) adjusts the electrical delay to balance the phase shift of the DUT. It simulates a variable length lossless transmission line, which can be added to or removed from a receiver input to compensate for interconnecting cables, etc. This function is similar to the mechanical or analog “line stretchers” of other analyzers. Delay is annotated in units of time with secondary labeling in distance for the current velocity factor.

With this feature, and with **MARKER → DELAY**, an equivalent length of air is added or subtracted according to the following formula:

$$\text{Length (meters)} = \frac{\phi}{\text{Frequency (MHz)} \times 1.20083}$$

Once the linear portion of the DUT's phase has been removed, the equivalent length of air can be read out in the active entry area. If the average relative permittivity (ϵ_r) of the DUT is known over the frequency span, the length calculation can be adjusted to indicate the actual length of the DUT more closely. This can be done by entering the relative velocity factor for the DUT using the calibrate more menu. The relative velocity factor for a given dielectric can be calculated by:

$$\text{Velocity factor} = \frac{1}{\sqrt{\epsilon_r}}$$

assuming a relative permeability of 1.

PHASE OFFSET (PHAO) adds or subtracts a phase offset that is constant with frequency (rather than linear). The allowable range is -360° to $+360^\circ$. This is independent of **MARKER → DELAY** and **ELECTRICAL DELAY**.

RETURN goes back to the scale reference menu.

DISPLAY Key

The HP-IB programming command is shown in parenthesis following the key or softkey.

The **DISPLAY** key provides access to dual channel display, active channel display title, frequency blanking, trace display ON/OFF, and graticule display ON/OFF.

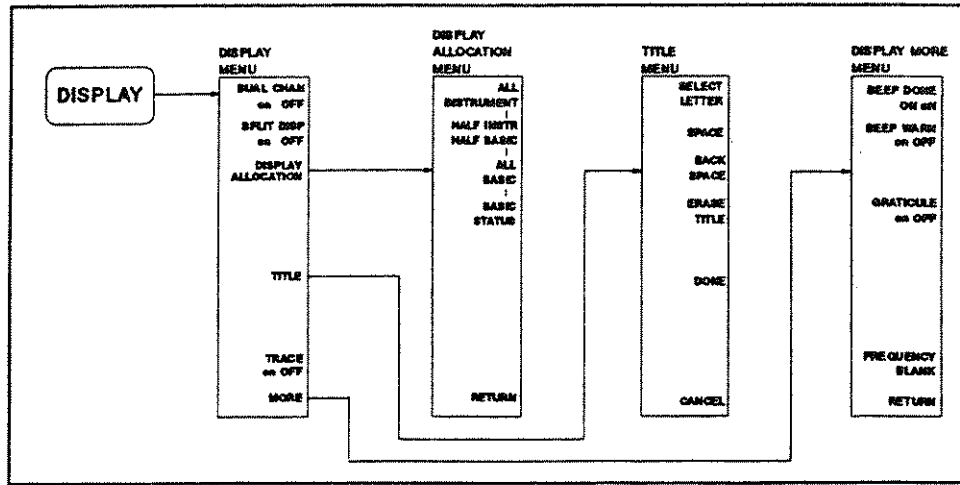

Figure 9-23. Softkey Menus Accessed from the **DISPLAY** Key

Display Menu

This menu provides the capability of displaying both channels simultaneously, either overlaid or split.

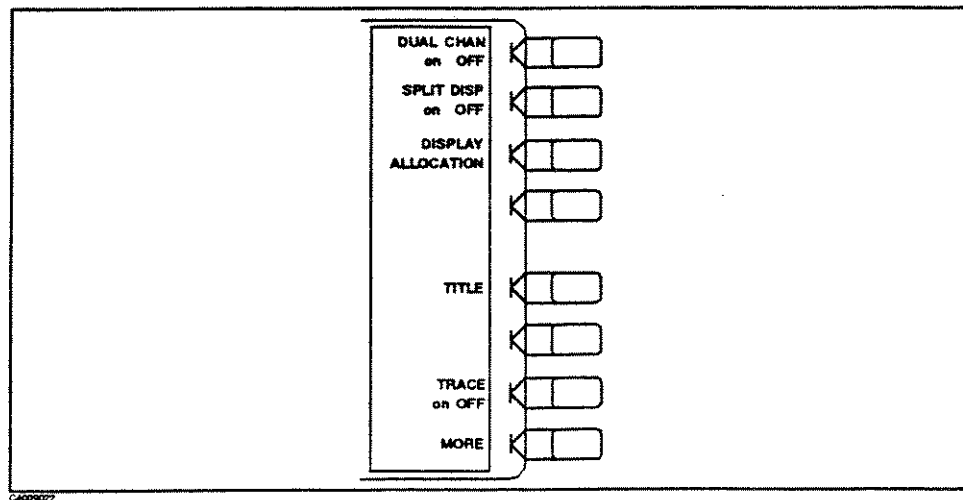

Figure 9-24. Display Menu

DUAL CHAN on OFF (DUACON, DUACOFF) toggles between display of both measurement channels or the active channel only. This is used in conjunction with **SPLIT DISP ON off** to display both channels.

SPLIT DISP on OFF (SPLDON, SPLDOFF) toggles between a full-screen single graticule display of one or both channels, and a split display with two half-screen graticules one

above the other. Both displays are illustrated in Figure 9-25. The split display can be used in conjunction with **DUAL CHAN ON** to show the measured data of each channel simultaneously on separate graticules. In addition, the stimulus functions of the two channels can be controlled independently using **COUPLED CH OFF** in the stimulus menu. The markers can also be controlled independently for each channel using **MARKERS: UNCOUPLED** in the marker mode menu.

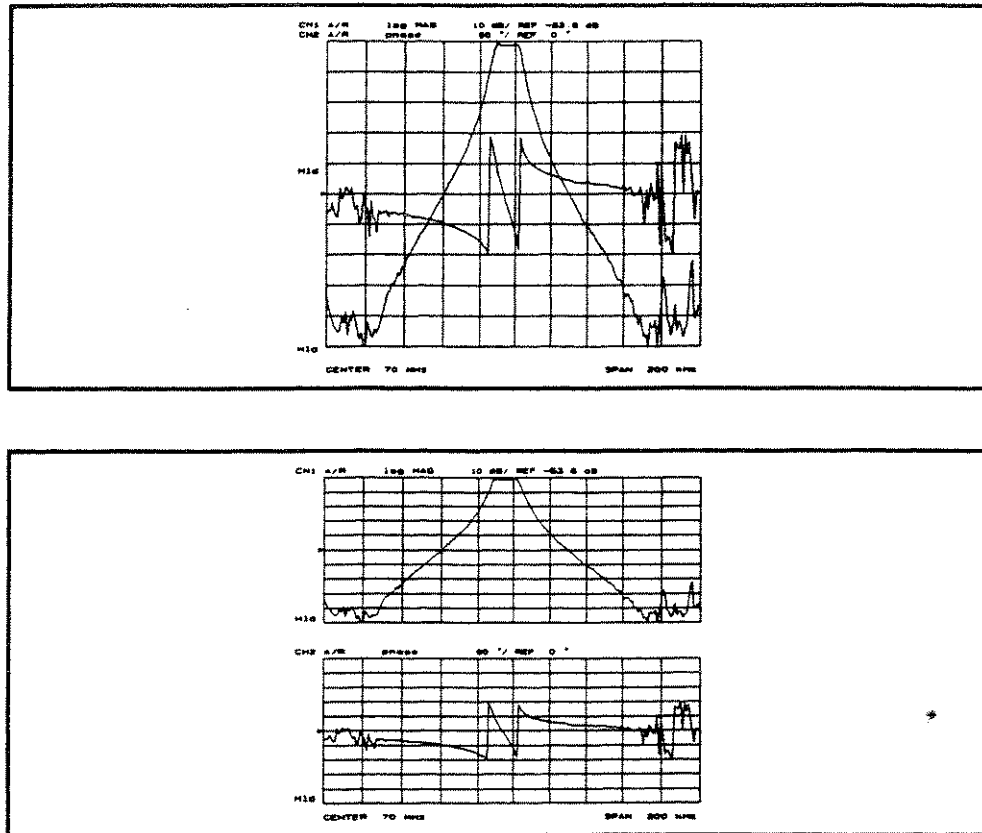

Figure 9-25. Full-screen and Split Display

DISPLAY ALLOCATION brings up the allocation menu which selects a full-screen display of measured data or the Instrument BASIC display, and a split display with two half-screens, one graticule display above the Instrument BASIC display.

TITLE (TITL) presents the title menu in the softkey labels area and the character set in the active entry area. These label the active channel display.

TRACE on OFF (TRADON, TRADOFF) toggles the trace display on the screen. This function does not affect the marker display. The markers are displayed on the screen even if the trace display is OFF. To erase markers, use **CLEAR MARKER** under the **(MKR)** key (See Chapter 11).

MORE leads to the display more menu.

Display More Menu

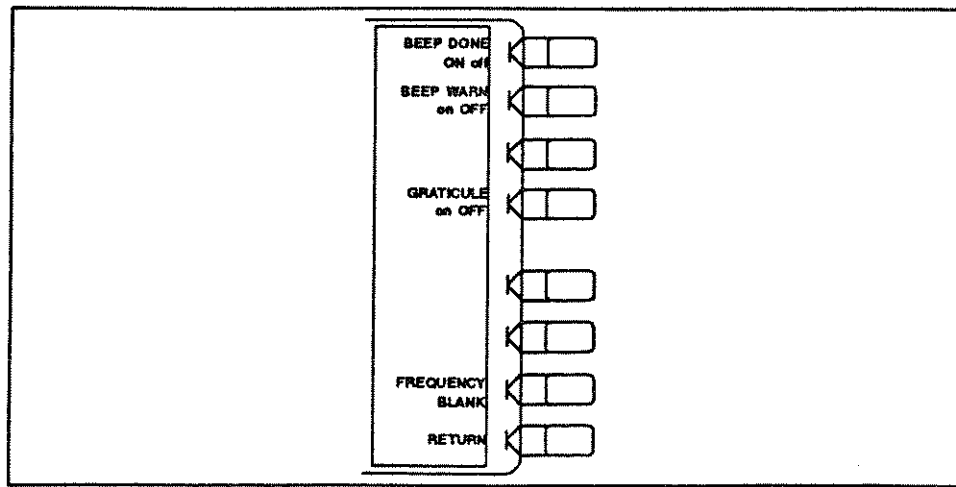

Figure 9-26. Display More Menu

BEEP DONE ON off (BEEPDONEON, BEEPDONEOFF) toggles an annunciator which sounds to indicate completion of certain operations such as calibration or instrument state save.

BEEP WARN on OFF (BEEPWARNON, BEEPWARNOFF) toggles the warning annunciator. When the annunciator is ON it sounds a warning when a cautionary message is displayed.

GRATICULE ON off (DISGON DISGOFF) toggles the graticule display on the screen. This function does not affect the trace display.

FREQUENCY BLANK (FREQ) blanks the displayed frequency notation for security purposes. Frequency labels cannot be restored except by instrument preset or turning the power OFF and then ON.

RETURN goes back to the display menu.

Display Allocation Menu

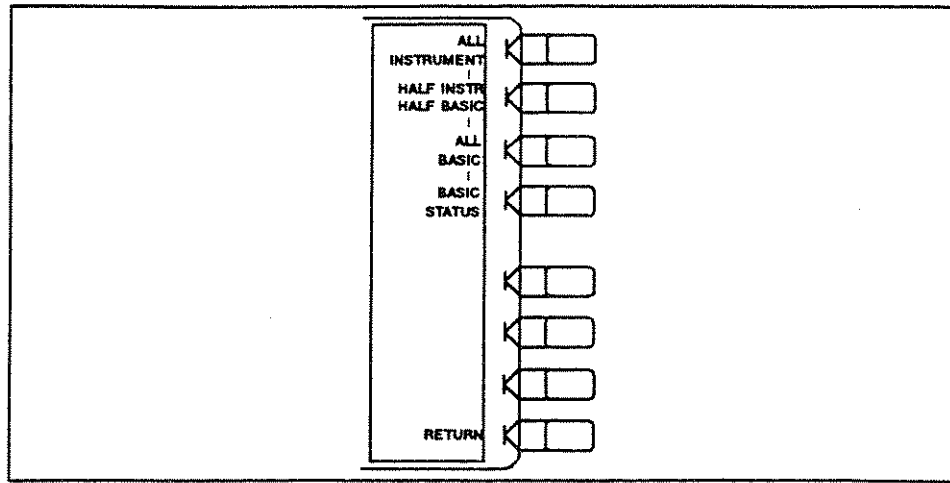

Figure 9-27. Display Allocation Menu

ALL INSTRUMENT (DISAALLI) selects a full screen single screen or two half-screen graticules.

HALF INSTR HALF BASIC (DISAHIHB) selects two half-screens, one graticule display above the Instrument BASIC display.

ALL BASIC (DISAALLB) selects a full screen single Instrument BASIC display.

BASIC STATUS (DISABASS) selects a full screen graticule and allocates three status lines for displaying status and entering commands of Instrument BASIC under the graticule.

RETURN goes back to the display menu.

Title Menu

Use this menu to specify a title for the active channel. The title identifies the display regardless of stimulus or response changes, and is printed or plotted with the data.

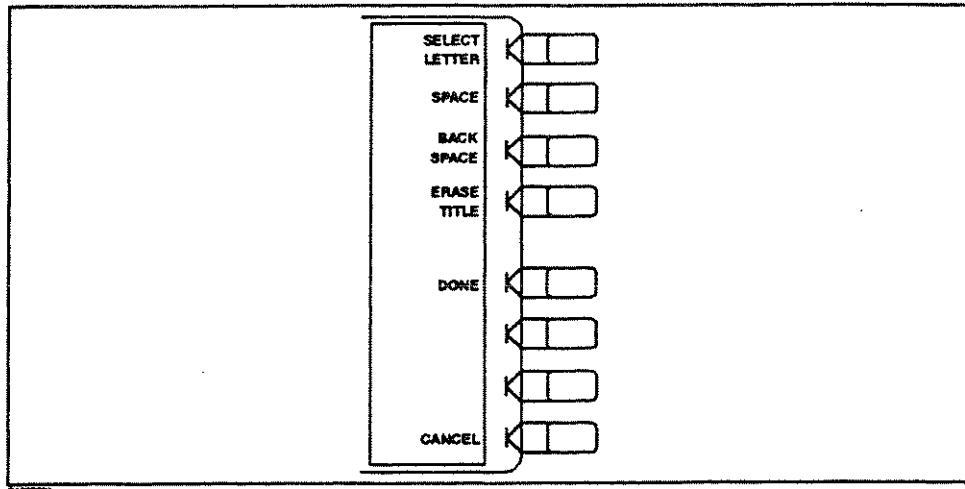

Figure 9-28. Title Menu

SELECT LETTER The active entry area displays the letters of the alphabet, digits 0 through 9, and some special characters including mathematical symbols. Three sets of letters can be scrolled using the step keys, \uparrow and \downarrow . To define a title, press step keys for the desired letter set, rotate the knob until the arrow “↑” points at the first letter, then press **SELECT LETTER**. As each letter is selected, it is appended to the title at the top of the graticule. Repeat this until the complete title is defined, a maximum of 53 letters. It is also possible to input the letters from the keyboard provided with Instrument BASIC (Option 002).

SPACE inserts a space in the title.

BACK SPACE deletes the last character entered.

ERASE TITLE deletes the entire title.

DONE terminates the title entry, and returns to the display more menu.

CANCEL cancels the title entry and returns to the display more menu without any change.

AVG Key

The HP-IB programming command is shown in parenthesis following the key or softkey.

The **AVG** key accesses four different noise reduction techniques: sweep-to-sweep averaging, display smoothing, variable IF bandwidth, and group delay aperture for group delay measurement. Any or all of these can be used simultaneously. Averaging, smoothing and group delay aperture can be set independently for each channel, and the IF bandwidth can be set independently if the stimulus is uncoupled.

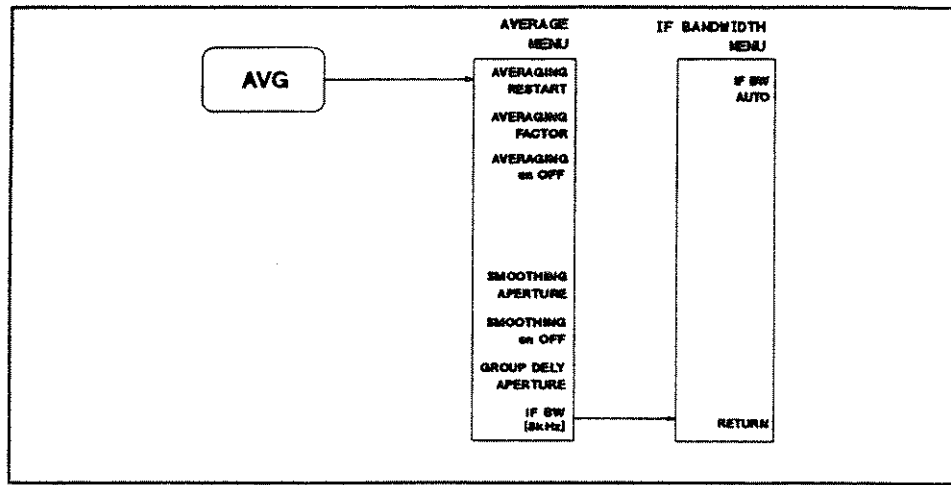

Figure 9-29. Softkey Menus Accessed from the **AVG** Key

Averaging

Averaging computes each data point based on an exponential average of consecutive sweeps weighted by a user-specified averaging factor. Each new sweep is averaged into the trace until the total number of sweeps is equal to the averaging factor, for a fully averaged trace. Each point on the trace is the vector sum of the current trace data and the data from the previous sweep. A high averaging factor gives the best signal-to-noise ratio, but slows the trace update time. Doubling the averaging factor reduces the noise by 3 dB. Figure 9-30 illustrates the effect of averaging on a log magnitude format trace.

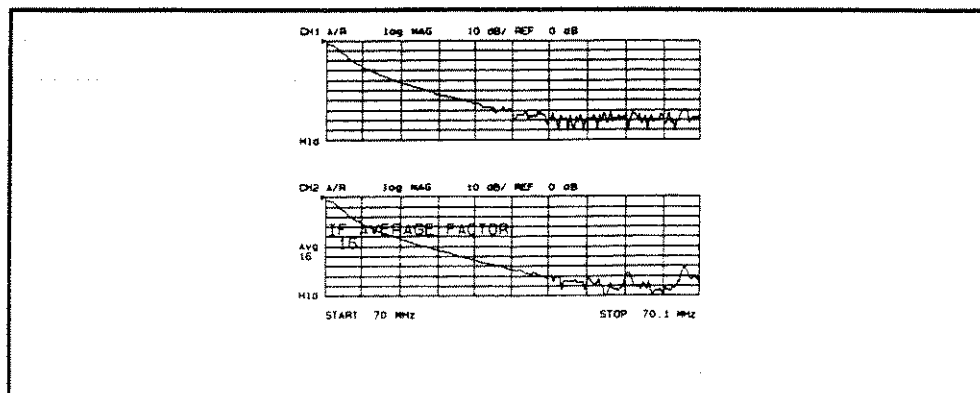

Figure 9-30. Effect of Averaging on a Trace

Smoothing

Smoothing (similar to video filtering) averages the formatted active channel data over a portion of the displayed trace. Smoothing computes each displayed data point based on one sweep only, using a moving average of several adjacent data points for the current sweep. The smoothing aperture is a percent of the stimulus span swept, up to a maximum of 100%.

Rather than lowering the noise floor, smoothing finds the mid-value of the data. Use it to reduce relatively small peak-to-peak noise values on broadband measured data. Use a sufficiently high number of display points to avoid misleading results. Do not use smoothing for measurements of high Q resonant devices or other devices with wide variations in the trace, as it will introduce errors into the measurement.

In polar display format, large phase shifts over the smoothing aperture will cause shifts in amplitude, since a vector average is being computed. Figure 9-31 illustrates the effect of smoothing on a log magnitude format trace.

If data and memory traces are displayed, smoothing is performed on both of them.

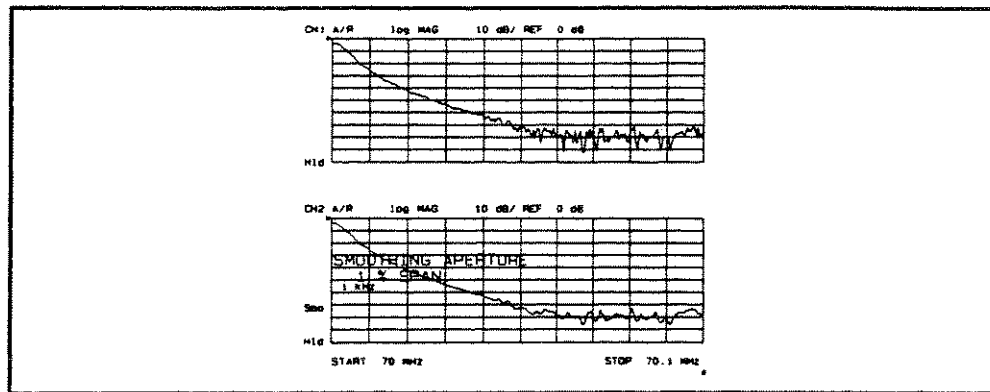

Figure 9-31. Effect of Smoothing on a Trace

IF Bandwidth Reduction

IF Bandwidth Reduction lowers the noise floor by reducing the receiver input bandwidth. It has an advantage over averaging in reliably filtering out unwanted responses such as spurs, odd harmonics, higher frequency spectral noise, and line-related noise. Sweep-to-sweep averaging, however, is better at filtering out very low frequency noise. A tenfold reduction in IF bandwidth (from 200 Hz to 20 Hz, for example) lowers the measurement noise floor by about 10 dB.

Another difference between sweep-to-sweep averaging and variable IF bandwidth is the sweep time. Averaging displays the first complete trace faster but takes several sweeps to reach a fully averaged trace. IF bandwidth reduction lowers the noise floor in one sweep, but the sweep time may be slower. Figure 9-32 illustrates the difference in noise floor between a trace measured with a 1 kHz IF bandwidth and with a 20 Hz IF bandwidth.

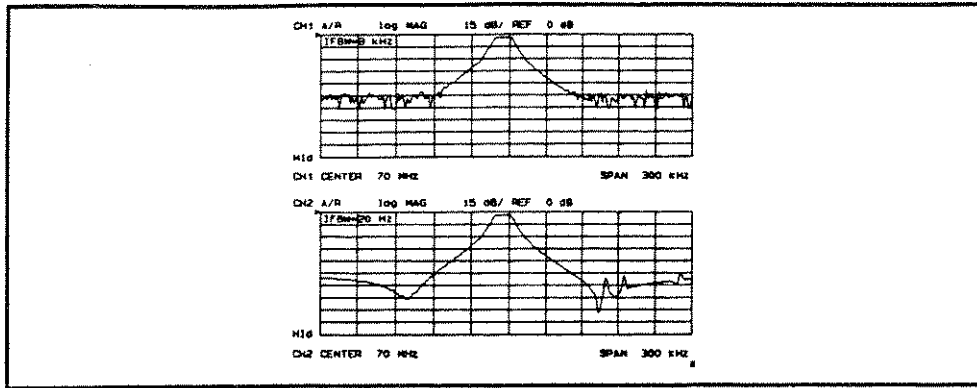

Figure 9-32. IF Bandwidth Reduction

Group Delay Aperture

Changing group delay aperture will lower the noise on the group delay trace. See Group Delay Principles earlier in this chapter.

Another capability that can be used for effective noise reduction is the marker statistics function, which computes the average value of part or all of the formatted trace. See Chapter 11.

Average Menu

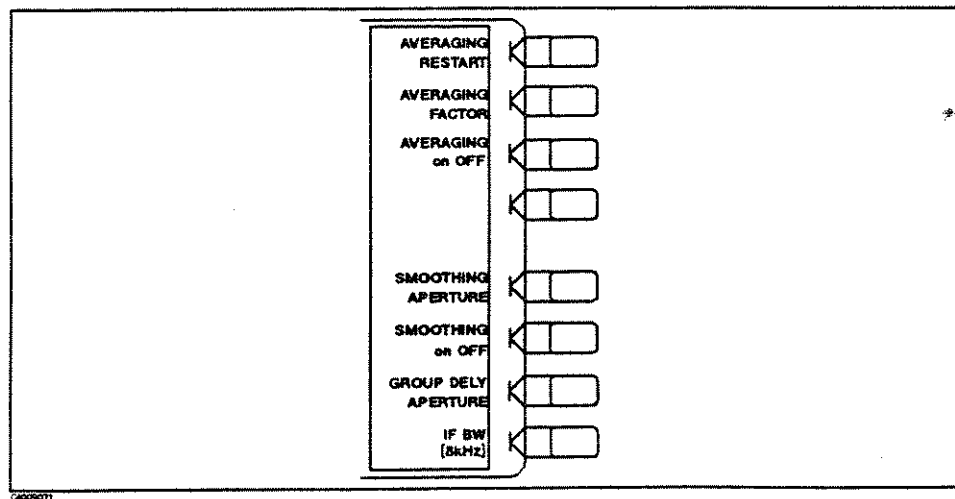

Figure 9-33. Average Menu

AVERAGING RESTART (AVERREST) resets the sweep-to-sweep averaging and restarts the sweep count at 1 at the beginning of the next sweep. The sweep count for averaging is displayed at the left of the display.

AVERAGING FACTOR (AVERFACT) makes averaging factor the active function. Any value up to 999 can be used. The algorithm used for averaging is:

$$A_{(n)} = \frac{S_{(n)}}{F} + \left(1 - \frac{1}{F}\right) \times A_{(n-1)}$$

where,

$A_{(n)}$ = current average

$S_{(n)}$ = current measurement

F = average factor

AVERAGING on OFF (AVERON, AVEROFF) turns the averaging function ON or OFF for the active channel. "Avg" is displayed in the status notations area at the left of the display, together with the sweep count for the averaging factor, when averaging is ON. The sweep count for averaging is reset to 1 whenever an instrument state change affecting the measured data is made.

At the start of averaging or following **AVERAGING RESTART**, averaging starts at 1 and averages each new sweep into the trace until it reaches the specified averaging factor. The sweep count is displayed in the status notations area below "Avg" and updated every sweep as it increments. When the specified averaging factor is reached, the trace data continues to be updated, weighted by that averaging factor.

SMOOTHING APERTURE (SMOOPER) lets you change the value of the smoothing aperture as a percent of the span. When smoothing aperture is the active function, its value in stimulus units is displayed below its percent value in the active entry area. The allowed range is 0.05 through 100 % of span and resolution is 0.001%.

SMOOTHING on OFF (SMOON, SMOOFF) turns the smoothing function ON or OFF for the active channel. When smoothing is ON, the annotation "Smo" is displayed in the status notations area. The algorithm used for smoothing is:

$$S_{m(n)} = \frac{D_{(n-m)} + \dots + D_{(n)} + \dots + D_{(n+m)}}{2m + 1}$$

where

$S_{m(n)}$ = smoothed data

$D_{(n)}$ = unsmoothed data

m : determined by smoothing aperture

GROUP DELAY APERTURE (GRODAPER) sets the aperture for group delay measurements as a percent of the span (see Group Delay Principles earlier in this chapter). A frequency aperture Δf at the active marker is displayed under the percent value when the format is DELAY.

IF BW (IFBW) selects the bandwidth value for IF bandwidth reduction. Allowed values (in Hz) are k, 4 k, 1 k, 200, and 20. Any other value will default to the closest allowed value. A narrow bandwidth slows the sweep speed but provides better signal-to-noise ratio. The selected bandwidth value is shown in brackets in the softkey label.

IF Bandwidth Menu

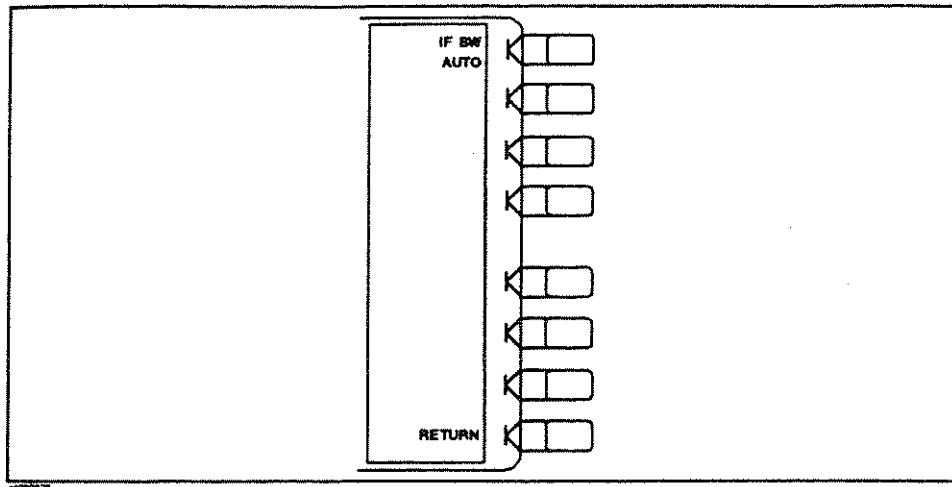

Figure 9-34. IF Bandwidth Menu

IF BW AUTO (IFBWAUTO) selects the proper IF bandwidth automatically for each measurement point while the measuring frequency is swept. This is convenient for getting fast and good performance when the log frequency sweep type is selected.

The best bandwidth depends on the measuring frequency. The relations between measuring frequency and IF bandwidth are as follows:

Table 9-1. IF Bandwidth in AUTO mode

Frequency	IF Bandwidth	*
1 kHz to 1.999 999 kHz	20 Hz	
2 kHz to 99.999 999 kHz	200 Hz	
100 kHz to 999.999 999 kHz	1 kHz	
1 MHz to 300 MHz	4 kHz	

RETURN goes back to the average menu.

SPCL FCTN Key

This key provides the special function menu, that quickly gets certain measurement parameters without going through the usual key sequence.

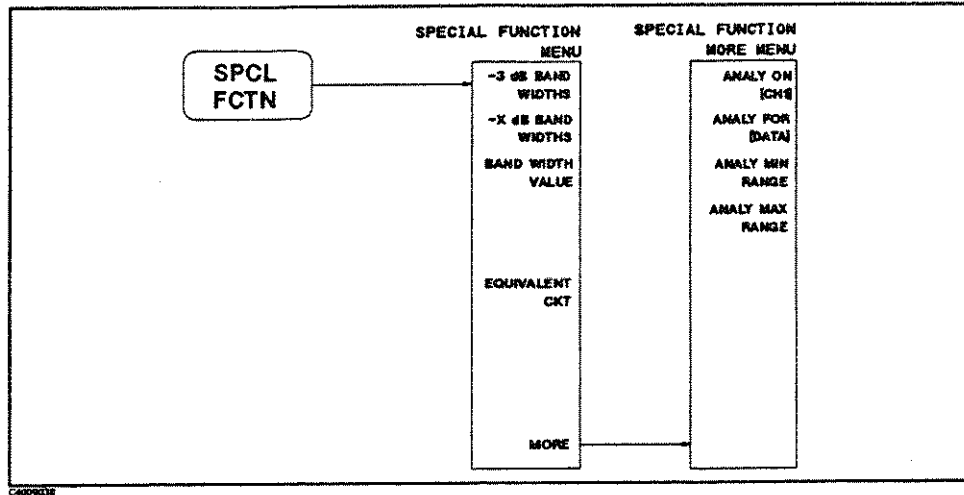

Figure 9-35. Softkey Menus Accessed from the SPCL FCTN Key

Special Function Menu

This menu has two functions, one derives filter parameters (for example, 3 dB bandwidth) and the other is statistical functions. These functions perform the same functions using the wave form analysis HP-IB commands. For more information on the wave form analysis commands, see Appendix E in the *HP-IB Programming Manual*.

Note These functions are independent of the marker function.

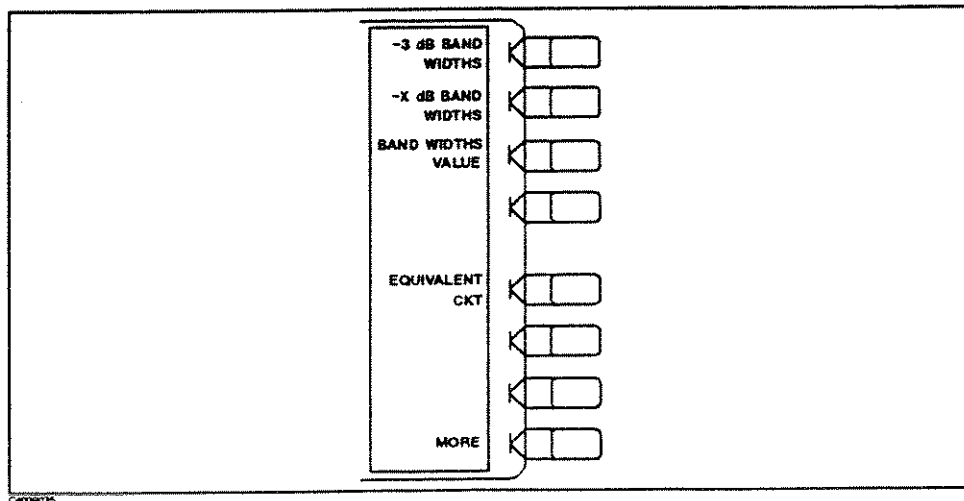

Figure 9-36. Special Function Menu

-3dB BAND WIDTH (OUTPFILT?) displays filter specific parameters, insertion loss, -3dB band width, frequency at the center point of two cutoff points (f_{cent}), Q , left cutoff point frequency (ΔLF), and right cutoff point frequency (ΔRF) within the range specified by **ANALY MIN** and **ANALY MAX**.

Figure 9-37 shows a typical example of a bandpass filter measurement trace. The insertion loss is the absolute value of the difference of the maximum within a specified range and 0 dB. BW is the stimulus width between two cutoff points (f_1 and f_2) and the center point of two cutoff points are given as f_{cent} . Q is calculated as:

$$Q = \frac{\sqrt{f_1 \times f_2}}{BW}$$

ΔLF is the stimulus difference between the left -3 dB cutoff point and the center point of a specified range. Similarly, ΔRF is the difference between the right cutoff point and the center of a specified range.

Zeros will be returned for all parameters when two -3 dB points can not be found.

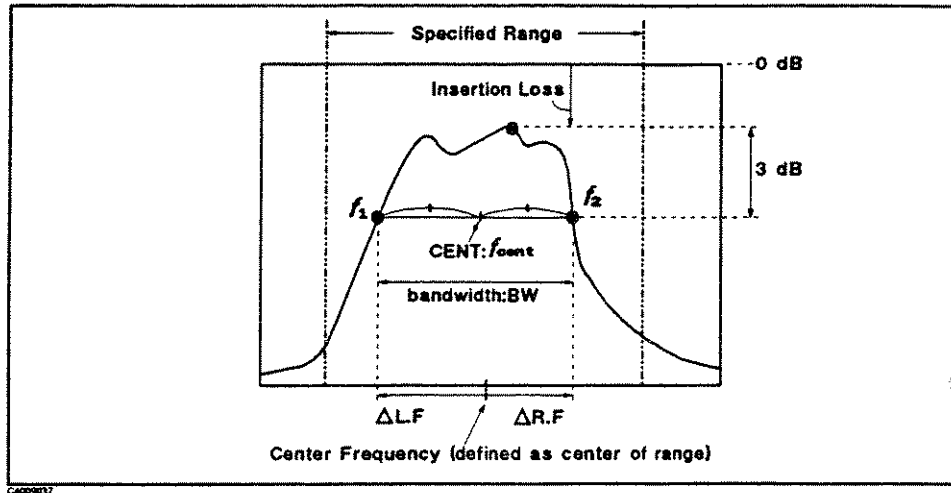

Figure 9-37. Output Filter Parameters Example

EQUIVALENT CKT (EQUCPARA?) derives four parameters for the equivalent circuit used for a crystal resonator, within the frequency range specified by **ANALY MIN** and **ANALY MAX**. The equivalent circuit is shown in Figure 9-38

Zeros will be returned for all parameters when if no parameters can be found.

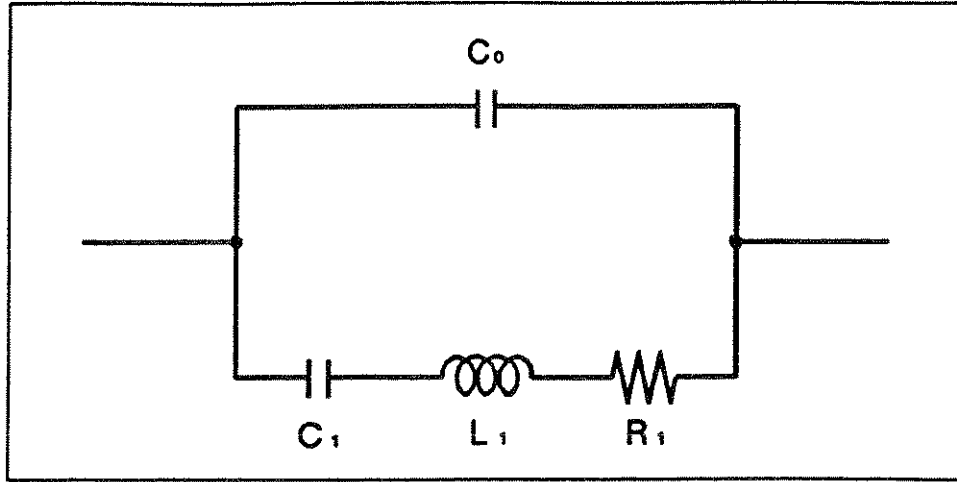

Figure 9-38. Four-Element Equivalent Circuit for Crystal Resonator

MORE provides the Special Function more menu described in the next section.

Special Function More Menu

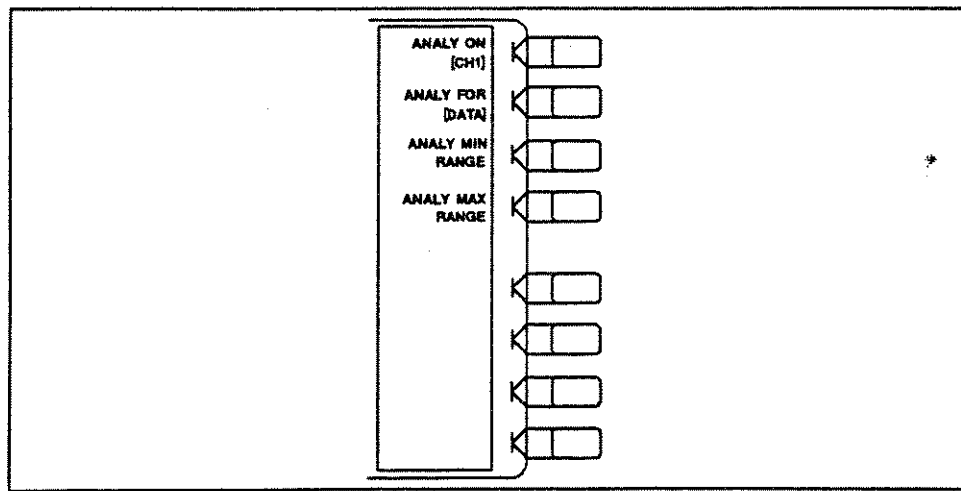

Figure 9-39. Special Function More Menu

ANALY ON [] (ANA0CH1, ANA0CH2) selects the channel to be used by the special functions.

[CH1] selects channel 1 and **[CH2]** selects channel 2. The channel selected is independent of the active channel.

ANALY FOR [] (ANA0DATA, ANA0MEMO) selects the object trace to be used by the special functions. **[DATA]** selects a data trace and **[SUB]** selects a sub trace for special functions.

Note

The target trace (DATA OR SUB) can be specified independently for each channel. The **ANALY ON** softkey is effective for the currently selected channel. So, **ANALY FOR** should be set after switching channels using **ANALY ON**.

ANALY MIN RANGE (ANARANG) sets the minimum frequency of the stimulus range (analysis range) for the special functions. The default setting for the analysis range is equal to the full stimulus range being set.

ANALY MAX RANGE (ANARANG) sets the maximum frequency of the stimulus range (analysis range) for the special functions. The default setting for the analysis range is equal to the full stimulus range being set.

RETURN returns to the input ports menu.

Note

ANALY MIN RANGE and **ANALY MAX RANGE** are specified independently from the marker search range.

When the analysis range exceeds the stimulus range being set, the analysis range is reset to match the stimulus range.

If the stimulus setting is modified after the analysis range is set, the HP 87510A resets the analysis range to the full range of the new stimulus range.

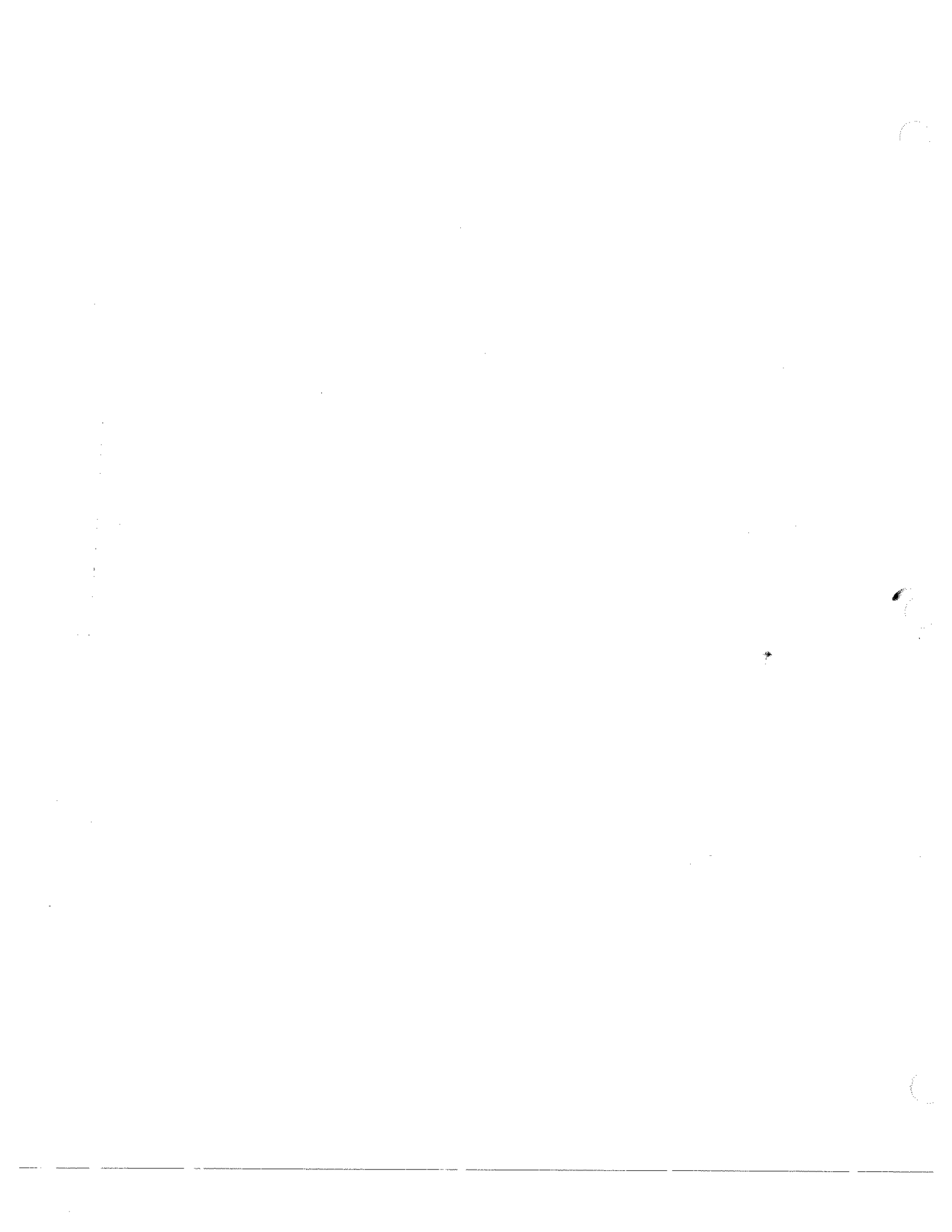

Measurement Calibration

Introduction

Measurement calibration is an accuracy enhancement procedure that effectively reduces the system errors that cause uncertainty when making a measurement (DUT). Known standard devices are measured, and the results of these measurements are used to characterize the system.

This chapter explains the theoretical fundamentals of accuracy enhancement and the sources of measurement errors. It describes the different measurement calibration procedures available in the analyzer, which errors they correct, and the measurements for which each should be used.

Accuracy Enhancement

If it were possible for a perfect measurement system to exist, it would have infinite dynamic range, isolation, and directivity characteristics, no impedance mismatches in any part of the test setup, and flat frequency response. Vector accuracy enhancement, also known as measurement calibration or error correction, provides the means to simulate a perfect measurement system.

In any high frequency measurement, there are measurement errors associated with the system that contribute uncertainty to the results. Parts of the measurement setup such as interconnecting cables and signal separation devices (as well as the analyzer itself) all introduce variations in magnitude and phase that can mask the actual performance of the device under test.

For example, crosstalk due to the channel isolation characteristics of the analyzer can contribute an error equal to the transmission signal of a high-loss test device. The measurement system cannot distinguish the true value of the signal reflected by the device under test from the signal arriving at the receiver input due to leakage in the system. For transmission measurements, impedance mismatches within the test setup cause measurement uncertainties that appear as ripples superimposed on the measured data.

Measurement calibration simulates a perfect analyzer system. It measures the magnitude and phase responses of known standard devices, and compares the measurement with actual device data. It uses the results to characterize the system and effectively remove the system errors from the measurement data of a test device, using vector math capabilities internal to the analyzer.

When measurement calibration is used, the dynamic range and accuracy of the measurement are limited only by system noise and stability, connector repeatability, and the accuracy to which the characteristics of the calibration standards are known.

Correcting for Measurement Errors

The analyzer has three different measurement calibration routines to characterize one or more of the systematic error terms and remove their effects from the measured data.

The **Response Calibration** effectively reduces the frequency response errors of the test setup for reflection or transmission measurements. This calibration procedure may be adequate for measurement of well matched low-loss devices.

The **Response and Isolation Calibration** effectively removes frequency response and crosstalk errors in transmission measurements. This procedure may be adequate for measurement of well matched high-loss devices.

The **3 term calibration** procedures provide the same correction measurements as the S_{11} 1-port calibration of conventional network analyzers. This calibration also applies to error correction for the π network measurement to test crystal resonators.

All the calibration procedures described above are accessed from the **CAL** key and are described in the following pages.

Menus and Softkeys

CAL Key

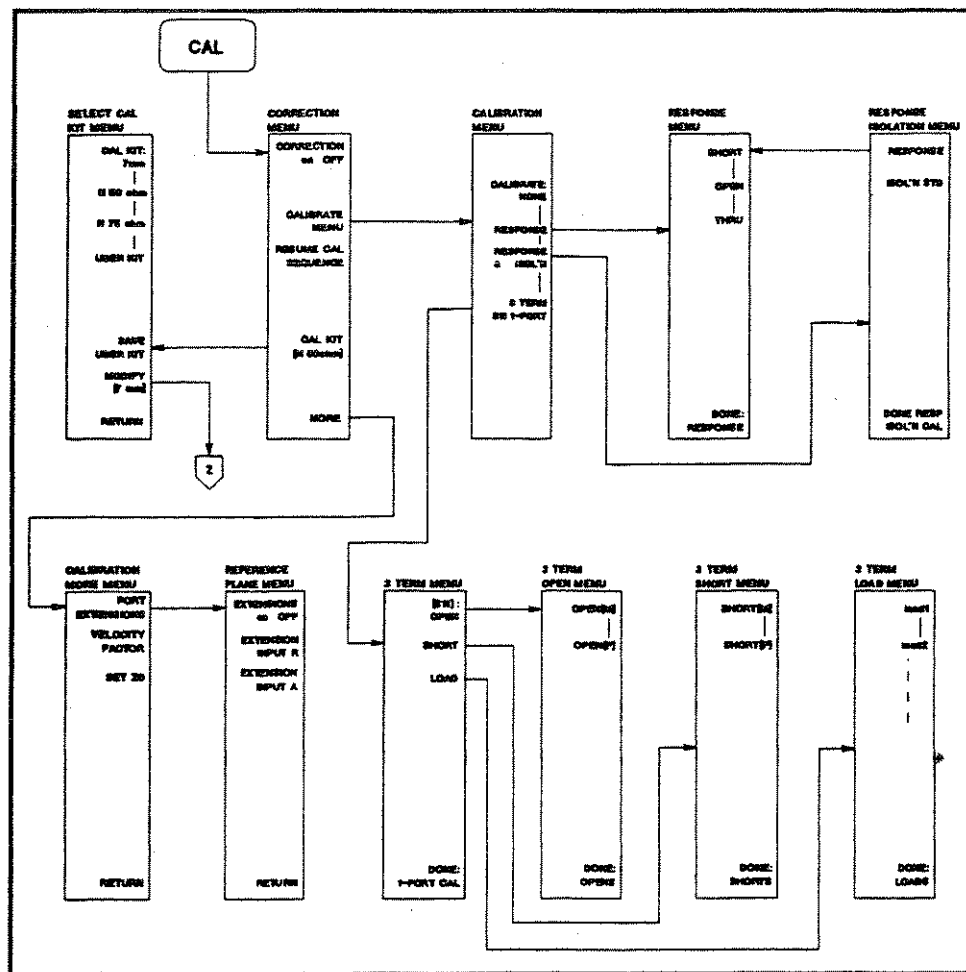

Figure 10-1. Softkey Menus Accessed from the **CAL** Key

The HP-IB programming command is shown in parenthesis following the key or softkey.

The **CAL** (KEY 15) key leads to a series of menus that implement the accuracy enhancement procedures described in the preceding pages (see Figure 10-1). Accuracy enhancement (error correction) is performed as a calibration step before measurement of a test device. The analyzer uses one of several different procedures to measure the systematic (repeatable) errors of the system and remove their effects from the measured data. The calibration menus and procedures are described and illustrated in the following pages. Each procedure compensates for one or more of the systematic error terms.

Interpolated Error Correction

The interpolated error correction feature allows the operator to change sweep range, or sweep type, without re-calibration. Interpolation is activated automatically when one or more of these stimulus parameters is changed as listed in the following table.

- Sweep range is changed to fall inside of the calibrated range.
- Sweep type is changed.
- Number of points is changed.

When interpolation is ON, the system errors for the newly selected frequencies are calculated from the system errors of the original calibration.

Note There is no softkey to turn OFF interpolation.



Interpolated error correction functions in all sweep modes: linear frequency, log frequency, and list sweep.

Channel Coupling

Up to four sets of measurement calibration data can be defined for each instrument state, one for each channel. If the two channels are stimulus coupled and the input ports are the same for both channels, they share the same calibration data. If the two channel inputs are different, they can have different calibration data. If the two channels are stimulus uncoupled, the measurement calibration applies to only one channel. For information on stimulus coupling, See Chapter 8.

Omitting Isolation Calibration

Isolation calibration can be omitted for most measurements, except where wide dynamic range is a consideration. Use the following guidelines. When the measurement requires a dynamic range of:

- under 80 dB: Omit isolation calibration for most measurements.
- 80 to 100 dB: Isolation calibration is recommended with approximately 0 dBm into the R input.
- over 100 dB: Averaging should be ON with an averaging factor ≥ 16 , both for isolation calibration and for measurement after calibration.

Stopping During the Calibration Procedure

You can stop at any point during a calibration procedure, without losing the steps you have already performed. No special steps are necessary to leave; just do whatever task you want. To continue the calibration where you left off, press **CAL** RESUME CAL SEQUENCE.

Saving Calibration Data

It is recommended that calibration data be saved on the built-in disk or in RAM disk memory. See Chapter 14. If a calibration is not saved, it will be lost if another calibration procedure is selected for the same channel. Instrument preset, power on, and instrument state recall will also clear the calibration data.

Specifying Calibration Kits

In addition to the menus for the different calibration procedures, the **CAL** key provides access to a series of menus used to specify the characteristics of the calibration standards used. Hewlett-Packard calibration kits are predefined, or the definitions can be modified to any set of standards used.

Correction Menu

The correction menu is the first menu presented by the **CAL** key, and it provides access to numerous menus of additional calibration features.

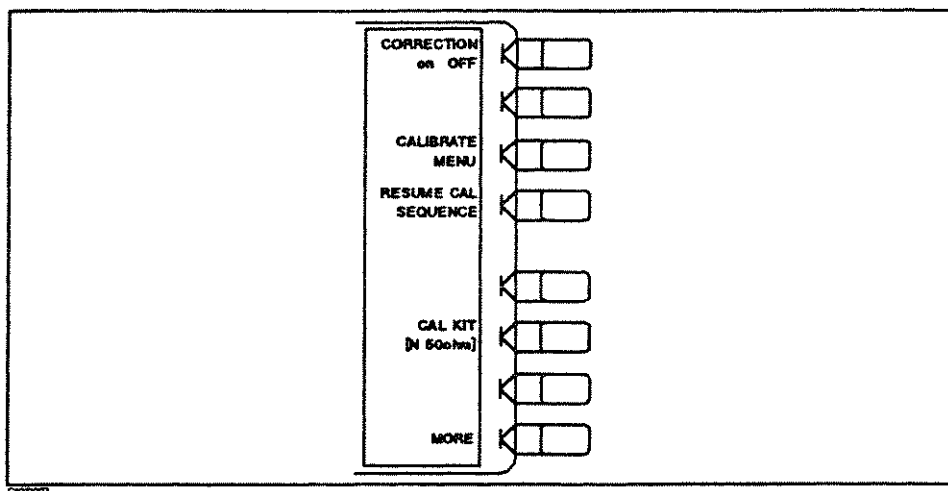

Figure 10-2. Correction Menu

CORRECTION on OFF (CORRON, CORROFF) turns error correction ON or OFF. The analyzer uses the most recent calibration data for the displayed parameter.

If one of the next stimulus parameters has been changed, correction is automatically turned OFF.

- Input measurement port is changed.
- Calibration type is changed.

If one of the next stimulus parameters has been changed, interpolated correction is automatically turned ON and the status notation is changed to "C?" (See "CRT Display" in Chapter 5).

- Sweep range is changed to fall inside of the calibrated range.
- Sweep type is changed.
- Number of Point is changed.

If one of the next stimulus parameters has been changed, the status notation is changed to "C!" (See "CRT Display" in Chapter 5). In this status, error corrections at a stimulus point will be done using calibration coefficient at the nearest calibrated frequency point.

- Sweep range is changed so both start and stop, or one of the start and stop stimulus values are/is out the calibrated range.

A calibration must be performed before correction can be turned ON. If no valid calibration data exists, the message "CALIBRATION REQUIRED" is displayed on the display.

It is recommended that calibration data be saved on the built-in disk or in RAM disk memory, using the capabilities described in Chapter 14.

CALIBRATE MENU leads to the calibration menu, which provides several accuracy enhancement procedures. At the completion of a calibration procedure, correction is automatically turned ON, and the notation "Cor" is displayed at the left of the screen.

RESUME CAL SEQUENCE (RESC) eliminates the need to restart a calibration sequence that was interrupted to access some other menu. This softkey goes back to the point where the calibration sequence was interrupted.

CAL KIT leads to the select cal kit menu, which selects one of the default calibration kits available for different connector types. This in turn leads to additional menus used to define calibration standards other than those in the default kits (See "Modifying Calibration Kits", later in this chapter). When a calibration kit has been specified, its connector type is displayed in brackets in the softkey label.

MORE provides access to the calibrate more menu, which extends the test port reference plane, to specify the characteristic impedance of the system, and the relative propagation velocity factor.

Select Cal Kit Menu

This selects the calibration kit for a measurement calibration. Selecting a cal kit chooses the model that mathematically describes the standard devices actually used.

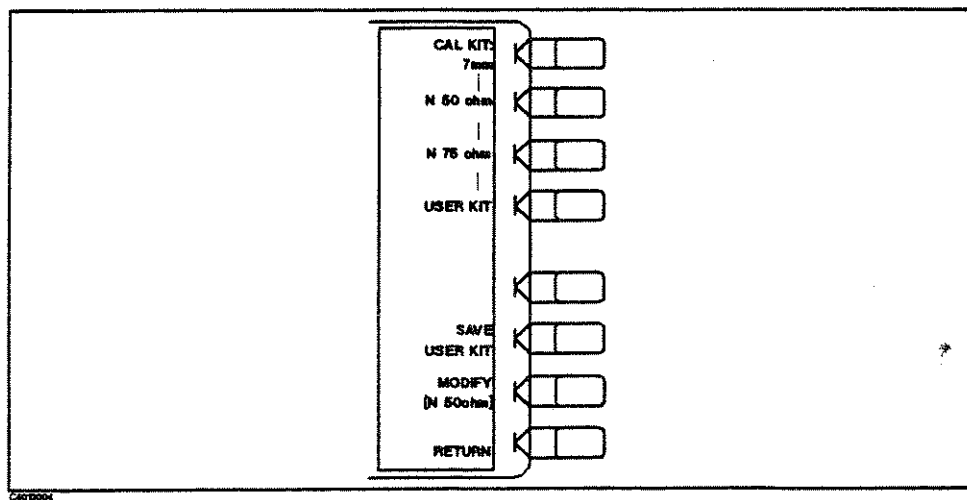

Figure 10-3. Select Cal Kit Menu

CAL KIT: 7mm (CALK7MM) selects the 7 mm cal kit model.

N 50Ω (CALKN50) selects the 50 Ω type-N model.

N 75Ω (CALKN75) selects the 75 Ω type-N model.

Note



If **N 50Ω** or **N 75Ω** is selected, additional menus are provided during calibration procedures to select the connector sex. This is the connector sex of the input port, not the actual calibration standard.

USER KIT (CALKUSED) selects a cal kit model defined or modified by the user. For information, See "Modifying Calibration Kits", later in this chapter.

SAVE USER KIT (SAVEUSEK) stores the user-modified or user-defined kit into memory, after it has been modified.

MODIFY (MODI1) leads to the modify cal kit menu, where a default cal kit can be user-modified.

RETURN returns to the correction menu.

Calibrate More Menu

This menu extends the test port reference plane, specifies the characteristic impedance of the system, and specifies the relative propagation velocity factor.

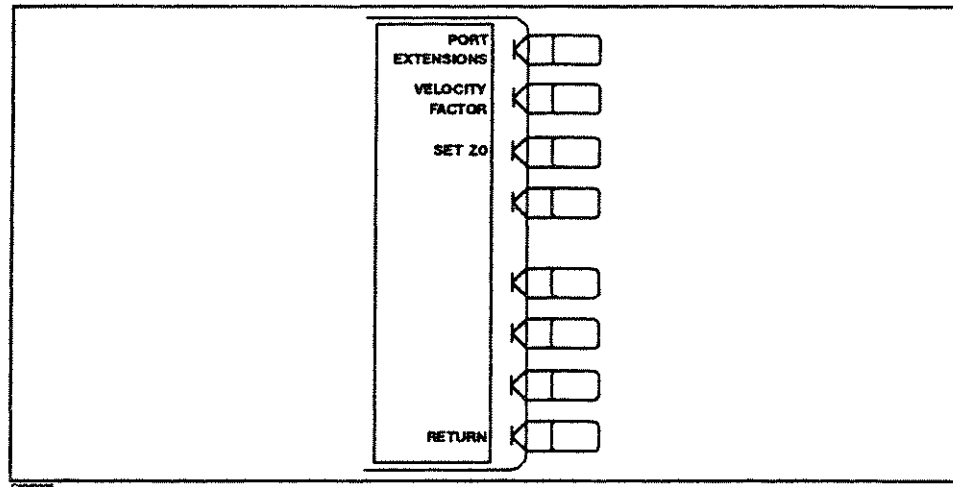

Figure 10-4. Calibrate More Menu

PORT EXTENSIONS goes to the reference plane menu, which extends the apparent location of the measurement reference plane or input.

The differences between the **PORT EXTENSIONS** and **ELECTRICAL DELAY** functions are described in the following table.

Table 10-1.
Differences between **PORT EXTENSIONS** and **ELECTRICAL DELAY**

	PORT EXTENSIONS	ELECTRICAL DELAY
Main Effect	The end of a cable becomes the test port plane for all measurements.	Compensates for the electrical length of a cable for the current type of measurement only.
Measurements Affected	All parameters.	Only the currently selected measurement parameter.

VELOCITY FACTOR (VELOFACT) enters the velocity factor used by the analyzer to calculate equivalent electrical length. Values entered should be less than 1. For example, the velocity factor of Teflon is:

$$V_f = \frac{1}{\sqrt{\epsilon_r}}$$

$$= 0.666$$

SET Z0 (SETZ) sets the characteristic impedance used by the analyzer in calculating measured impedance with conversion parameters. Characteristic impedance must be set correctly before calibration procedures are performed.

RETURN goes back to the correction menu.

Reference Plane Menu

This adds electrical delay in seconds to the measurement ports to extend the apparent location of the measurement reference plane to the ends of the cables. This is equivalent to adding a length of perfect air line, and makes it possible to measure the delay response of the DUT only, instead of the DUT plus the adapter, cable, or other incidental device. Read the previous description of Port Extension for more information.

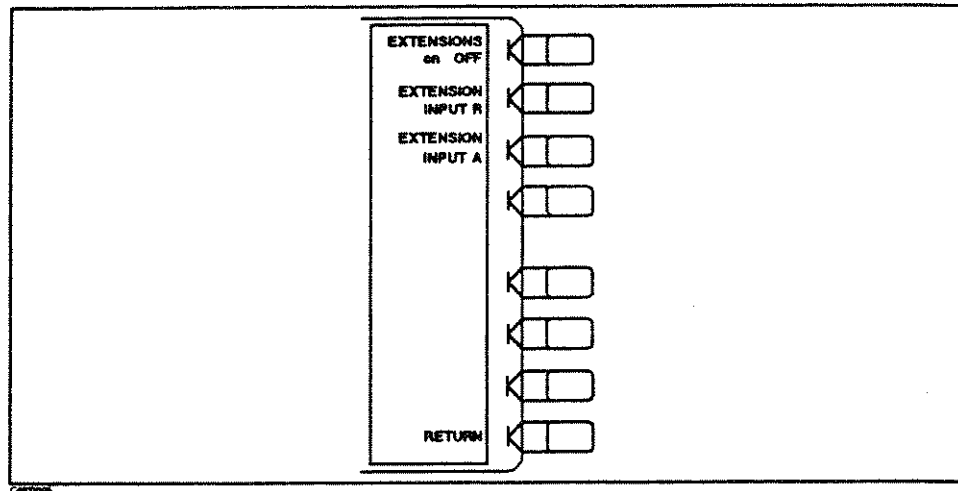

Figure 10-5. Reference Plane Menu

EXTENSIONS on OFF (POREON, POREOFF) toggles the reference plane extension mode. When this function is ON, all extensions defined below are enabled; when OFF, none of the extensions are enabled.

EXTENSION INPUT R (PORTR) adds electrical delay in seconds to extend the reference plane at input R to the end of the cable. This is used for any R input measurements.

EXTENSION INPUT A (PORTA) adds electrical delay to the input A reference plane for any A input measurements.

RETURN goes back to the calibrate more menu.

Calibration Menu

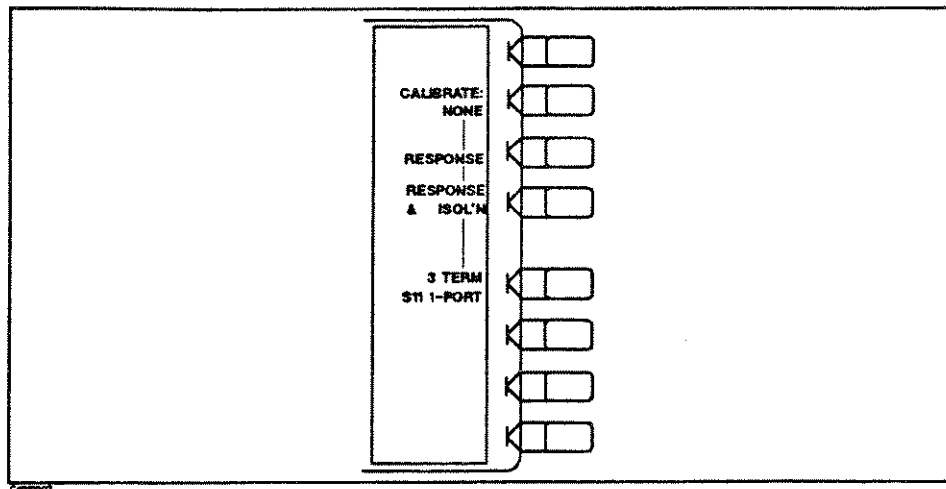

Figure 10-6. Calibration Menu

CALIBRATE: NONE (CALM) is underlined if no calibration has been performed or if the calibration data has been cleared. Unless a calibration is saved on the internal disk, the calibration data is lost on instrument preset, power ON, or instrument state recall. RESPONSE (CALIRESP) leads to the frequency response calibration. It effectively removes the frequency response errors of the test setup for transmission measurements.

Only a single calibration standard is required with this procedure. The standard for transmission measurements is a THRU. If more than one device is measured, only the data for the last device is retained. The procedures for response calibration for a reflection measurement and a transmission measurement are described in the following pages.

RESPONSE & ISOL'N (CALIRAI) leads to the menus used to perform a response and isolation measurement calibration, for measurement of devices with wide dynamic range. This procedure effectively reduces the same errors as the response calibration. In addition, it effectively reduces the isolation (crosstalk) error in transmission measurements. As well as the devices required for a simple response calibration, an isolation standard is required. The standard normally used to correct for isolation is an impedance-matched LOAD (usually 50 or 75 Ω). Response and directivity calibration procedures for transmission measurement is provided in the following pages.

3 TERM S11 1-PORT (CALIS111) leads to the menus used to perform a 3 term calibration (S_{11} 1-port measurement calibration). The 3 Term calibration procedures provide the same correction measurements as the S_{11} 1-port calibration of conventional network analyzers. This calibration also applies to error correction for the π network measurement to test crystal resonators.

Response Calibration for Transmission Measurements

This performs a frequency response only calibration for a transmission measurement.

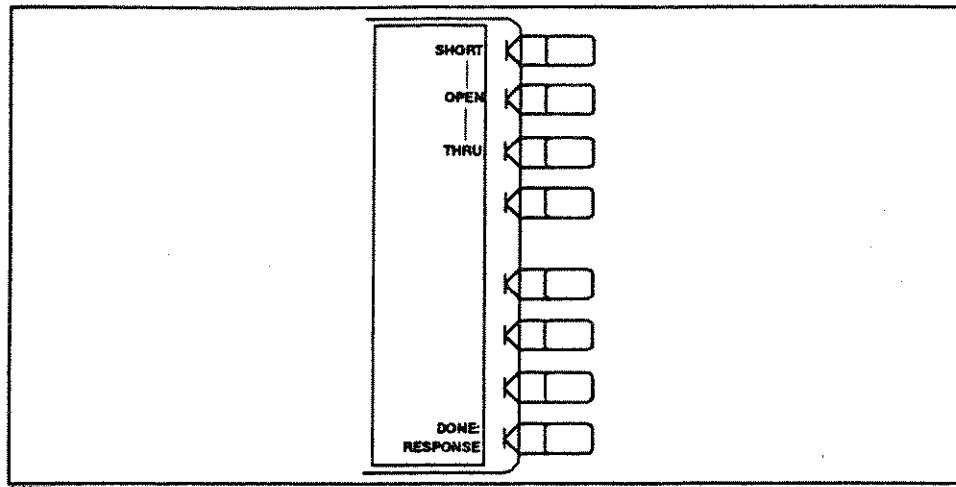

Figure 10-7. Response Cal Menu

Procedure

1. Press **MEAS** A/R.
2. Press **CAL**.
3. Press **CALIBRATE MENU RESPONSE**.
4. Connect a THRU (connect together the points at which the test device will be connected).
5. When the trace settles, press THRU.
6. The message "WAIT - MEASURING CAL STANDARD" is displayed while the data is measured. The softkey label THRU is then underlined.
7. Press **DONE: RESPONSE** to complete the calibration. The error coefficients are computed and stored. The correction menu is displayed with **CORRECTION ON**. Corrected data is displayed.

Now the test device can be connected and measured. It is recommended that calibration data be saved using the built-in disk drive. See Chapter 14.

Response and Isolation Calibration for Transmission Measurements

This effectively reduces the frequency response and isolation errors for transmission measurements of devices with wide dynamic range.

Procedure

1. Press **MEAS** A/R.
2. Press **CAL**.
3. Press **CALIBRATE MENU RESPONSE & ISOL'N RESPONSE**.
4. Connect a cable between RF Output 2 and Input R.

5. Connect a THRU between RF OUTPUT 1 and Input A at the points where the test device will be connected.
6. When the trace has settled, press **THRU**. Response data is measured. The softkey label **THRU** is underlined.
7. Press **DONE: RESPONSE**.
8. Connect impedance-matched LOADs to RF Output 1 and Input A. Press **ISOL'N STD**. The isolation data is measured. The softkey label is underlined.
9. Press **DONE RESP ISOL'N CAL** to complete the calibration. The error coefficients are computed and stored. The correction menu is displayed with **CORRECTION ON**. Corrected data is displayed and the notation "Cor" at the left of the screen indicates that correction is ON for this channel.

It is recommended that calibration data be saved on a built-in disk or in RAM disk memory. See Chapter 14.

Modifying Calibration Kits

Note



Hewlett-Packard strongly recommends that you read application note 8510-5A before attempting to view or modify calibration standard definitions. The part number of this application note is 5956-4352. Although the application note is written for the HP 8510 family of network analyzers, it also applies to the HP 87510A. This portion of the calibration chapter provides a summary of the information in the application note, as well as HP 87510A menu-specific information.

For most applications, use the default cal kit models provided in the select cal kit menu described earlier in this chapter. Modifying calibration kits is necessary only if unusual standards are used or the very highest accuracy is required. Unless a cal kit model is provided with the calibration devices used, a solid understanding of error correction and the system error model are absolutely essential to making modifications. Read the introductory part of this chapter for more information, and See the Appendix to Chapter 10.

Note



Numerical data for most Hewlett-Packard calibration kits is provided in the calibration kit manuals.

During measurement calibration, the analyzer measures actual, well-defined standards and mathematically compares the results with ideal "models" of those standards. The differences are separated into error terms which are later reduced during error correction. Most of the differences are due to systematic errors - repeatable errors introduced by the analyzer, test set, and cables - which are correctable. However, the difference between the standard's mathematical *model* and its *actual performance* has an adverse affect; it reduces the system's ability to remove systematic errors, and thus degrades error-corrected accuracy. Therefore, in addition to the default cal kit models, a "user kit" is provided that can be modified to an alternate calibration standards model.

Several situations exist that may require a user-defined cal kit:

- You use a connector interface different from the three built-in cal kits. (Examples: SMA, or BNC.)
- You are using standards (or combinations of standards) that are different from the predefined cal kits. (Example: Using three offset SHORTs instead of OPEN, SHORT, and LOAD to perform a 1-port calibration.)
- You want to improve the built-in standard models for predefined kits. Remember that the more closely the model describes the actual performance of the standard, the better the calibration. (Example: The 7 mm LOAD is determined to be 50.4 Ω instead of 50.0 Ω .)
- Unused standards for a given cal type can be eliminated from the default set, to eliminate possible confusion during calibration. (Example: A certain application requires calibrating a male test port. The standards used to calibrate a female test port can be eliminated from the set, and will not be displayed during calibration.)

Definitions

The following are definitions of terms:

- A **standard** is a specific, well-defined, physical device used to determine systematic errors.
- A **standard type** is one of five basic types that define the form or structure of the model to be used with that standard (e.g. SHORT or LOAD).
- **Standard coefficients** are numerical characteristics of the standards used in the model selected.
- A **standard class** is a grouping of one or more standards that determines which standards are used in a particular calibration procedure.

Procedure

The following steps are used to modify or define a user kit:

1. Select the predefined kit to be modified. This is not necessary for defining a new cal kit.
2. Define the standards. For each standard, define which *type* of standard it is and its electrical characteristics.
3. Specify the *class* where the standard is to be assigned.
4. Store the modified cal kit.

The standard definitions of predefined calibration kits are shown in Appendix B.

Modify Cal Kit Menu

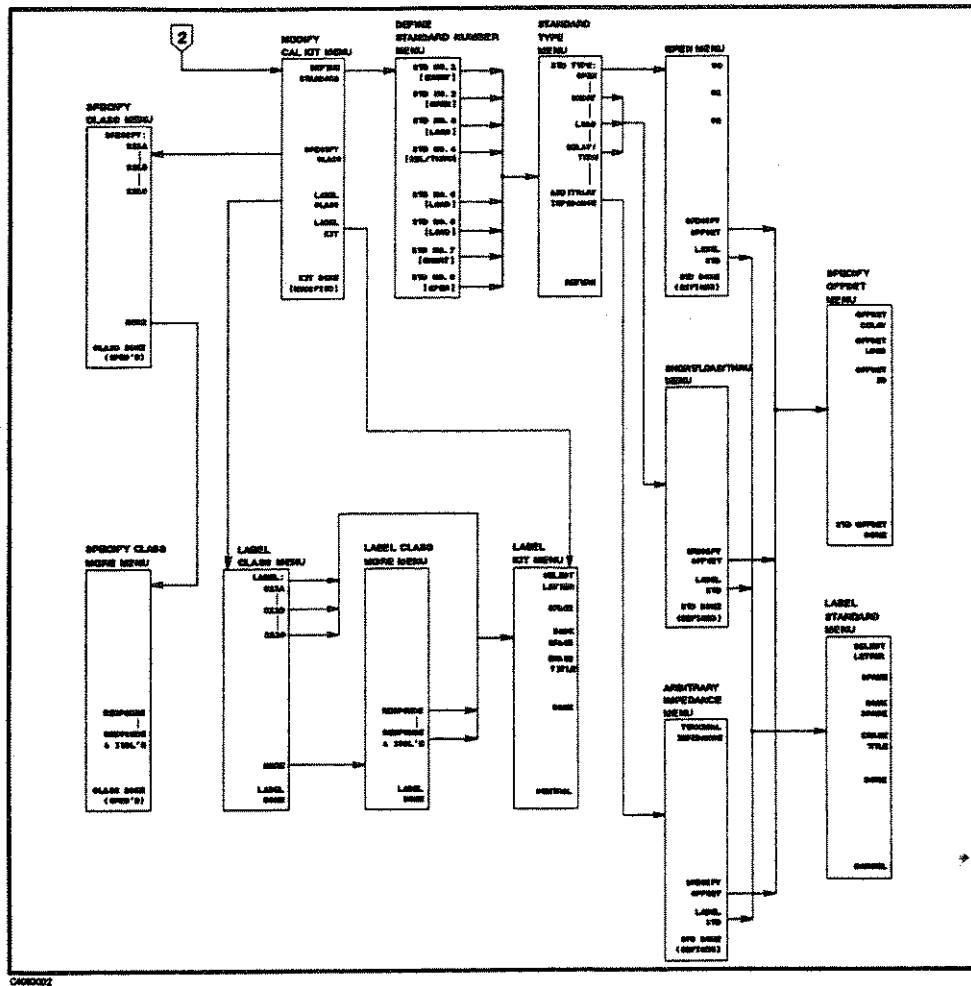

Figure 10-8. Modify Cal Kit Menus

This menu is accessed from **CAL** **CAL KIT MODIFY** (See Figure 10-1), and leads to additional menus associated with modifying cal kits. The analyzer directly supports 7 mm, 50Ω type-N, and 75Ω type-N connector types.

For other connector types, you must modify the existing standards definitions. This menu provides access to the default calibration standards definitions. A “User Kit” is provided for convenience. It can be redefined without affecting the definitions.

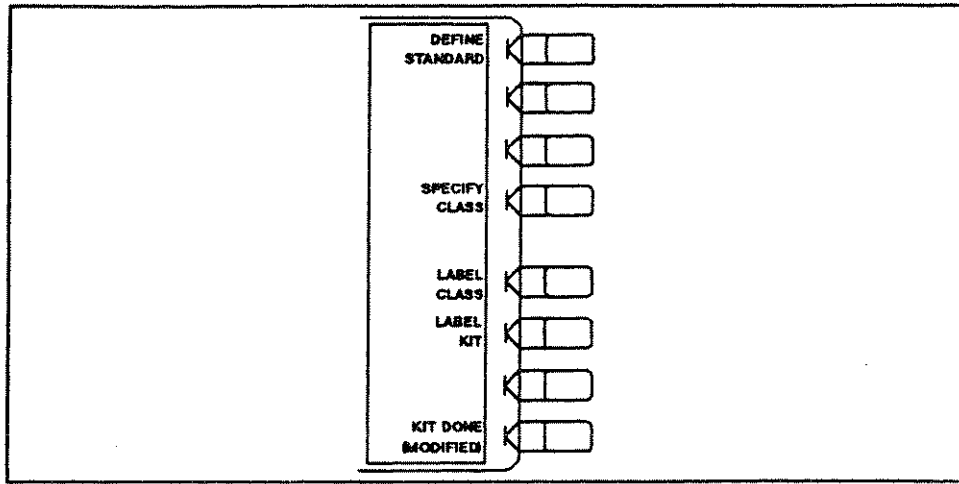

Figure 10-9. Modify Cal Kit Menu

DEFINE STANDARD (DEFS) makes the standard number the active function, and brings up the define standard number menus. The standard number (1 to 8) is an arbitrary reference number used to reference standards while specifying a class. Each number is similar to a register, in that it holds certain information. Each contains the selected type of device (OPEN, SHORT, or THRU) and the electrical model for that device. The standard numbers for the predefined calibration kits are as follows:

1 SHORT	5 LOAD
2 OPEN	6 LOAD
3 LOAD	7 SHORT
4 DEL/THRU	8 OPEN

SPECIFY CLASS leads to the specify class menu. After the standards are modified, use this key to specify a class to consist of certain standards.

LABEL CLASS leads to the label class menu, to give the class a meaningful label for future reference.

LABEL KIT (LABK) leads to a menu for constructing a label for the user-modified cal kit. If a label is supplied, it will appear as one of the five softkey choices in the select cal kit menu. The approach is similar to defining a display title, except that the kit label is limited to ten characters. See **DISPLAY** Key, Title Menu in Chapter 9 for details.

KIT DONE (KITD) terminates the cal kit modification process, after all standards are defined and all classes are specified. Be sure to save the kit with the **SAVE USER KIT** softkey, if it is to be used later.

Define Standard Number Menu

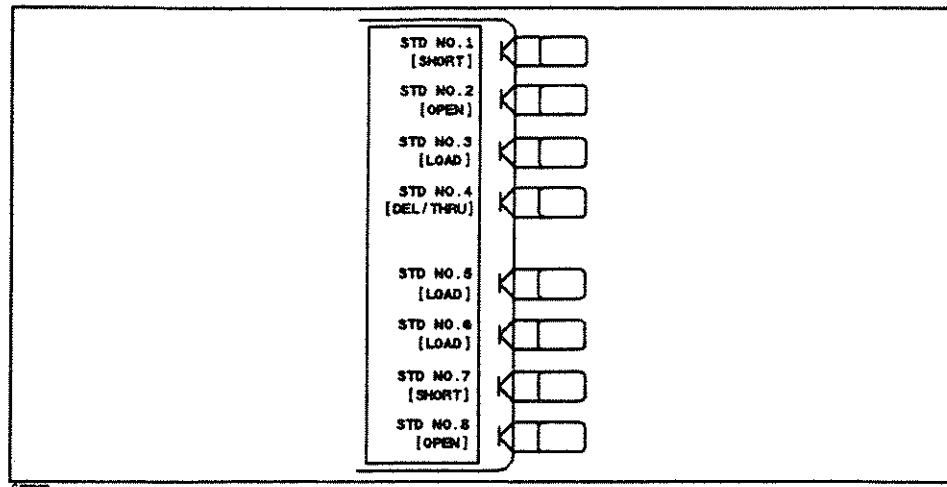

Figure 10-10. Define Standard Number Menu

STD NO. 1 selects standard No.1 as the standard definition.

STD NO. 2 selects standard No.2 as the standard definition.

STD NO. 3 selects standard No.3 as the standard definition.

STD NO. 4 selects standard No.4 as the standard definition.

STD NO. 5 selects standard No.5 as the standard definition.

STD NO. 6 selects standard No.6 as the standard definition.

STD NO. 7 selects standard No.7 as the standard definition.

STD NO. 8 selects standard No.8 as the standard definition.

Define Standard Menus

Standard definition is the process of mathematically modeling the electrical characteristics (delay, attenuation, and impedance) of each calibration standard. These electrical characteristics (coefficients) can be mathematically derived from the physical dimensions and material of each calibration standard, or from its actual measured response. The parameters of the standards can be listed in Standards Definitions, Table 10-2. The menus illustrated in Figure 10-10 specify the type and characteristics for each user-defined standard.

Table 10-2. Standard Definitions

NO.	STANDARD TYPE	C0 x 10 ⁻¹⁵ F	C1 x 10 ⁻²⁷ F/Hz	C2 x 10 ⁻³⁶ F/Hz ²	OFFSET DELAY ps	OFFSET LOSS MΩ/s	OFFSET Z ₀ Ω	STANDARD LABEL
1								
2								
3								
4								
5								
6								
7								
8								

Each standard must be identified as one of five “types”: OPEN, SHORT, LOAD, DELAY/THRU, or arbitrary impedance.

After a standard number is entered, selection of the standard type will present one of five menus for entering the electrical characteristics (model coefficients) corresponding to that standard type. These menus are tailored to the current type, so that only characteristics applicable to the standard type can be modified.

Any standard type can be further defined with offsets in delay, loss, and standard impedance (Z₀). Press the **SPECIFY OFFSET** key, and See the specify offset menu.

A distinct label can be defined and assigned to each standard, so that the analyzer can prompt the user with explicit standard labels during calibration (e.g. “SHORT”). Press the **LABEL STD** softkey. The function is similar to defining a display title, except that the label is limited to ten characters. See **DISPLAY** Key, “Title Menu” in Chapter 9 for details. After each standard is defined, including offsets, press **STD DONE (DEFINED)** to terminate the standard definition.

The standard definitions can be listed on screen and printed using the COPY function. (See Chapter 13.)

OPEN (STDTOPEN) defines the standard type as an OPEN, used for calibrating reflection measurements. OPENS are assigned a terminal impedance of infinite ohms, but delay and loss offsets may still be added. Pressing this key also brings up a menu for defining the OPEN, including its capacitance.

As a reflection standard, an OPEN offers the advantage of broadband frequency coverage. However, an OPEN rarely has perfect reflection characteristics because fringing (capacitance) effects cause phase shift that varies with frequency. These effects are impossible to eliminate, but the calibration kit models include the OPEN termination capacitance at all frequencies for compatible calibration kits. The capacitance model is a second order polynomial (squared term), as a function of frequency, where the polynomial coefficients are user-definable. The capacitance model equation is:

$$C = C_0 + C_1 \times F + C_2 \times F^2$$

where F is the measurement frequency.

The terms in the equation are defined with the specify open menu as follows:

C0 (C0) enters the C₀ term, which is the constant term of the quadratic equation and is scaled by 10⁻¹⁵ Farads.

C1 (C1) enters the C_1 term, expressed in F/Hz (Farads/Hz) and scaled by 10^{-27} .

C2 (C2) enters the C_2 term, expressed in F/Hz² and scaled by 10^{-36} .

SHORT (STDTSHOR) defines the standard type as a SHORT, for calibrating reflection measurements. SHORTs are assigned a terminal impedance of 0 Ω , but delay and loss offsets may still be added.

LOAD (STDTLOAD) defines the standard type as a LOAD (termination). LOADs are assigned a terminal impedance equal to the system characteristic impedance Z_0 , but delay and loss offsets may still be added. If the LOAD impedance is not Z_0 , use the arbitrary impedance standard definition.

DELAY/THRU (STDTDELA) defines the standard type as a transmission line of specified length, for calibrating transmission measurements.

ARBITRARY IMPEDANCE (STDTARBI) defines the standard type to be a LOAD, but with an arbitrary impedance (different from system Z_0).

TERMINAL IMPEDANCE (TERI) specifies the (arbitrary) impedance of the standard, in ohms.

STD DONE(DEFINED) terminates the standard definition. Press this after each standard defined, including offsets.

Specify Offset Menu

The specify offset menu allows additional specifications for a user-defined standard. Features specified in this menu are common to all five types of standards.

Offsets may be specified with any standard type. This means defining a uniform length of transmission line to exist between the standard being defined and the actual measurement plane. For reflection standards, the offset is assumed to be between the measurement plane and the standard (one-way only). For transmission standards, the offset is assumed to exist between the two reference planes (in effect, the offset is the THRU). Three characteristics of the offset can be defined: its delay (length), loss, and impedance.

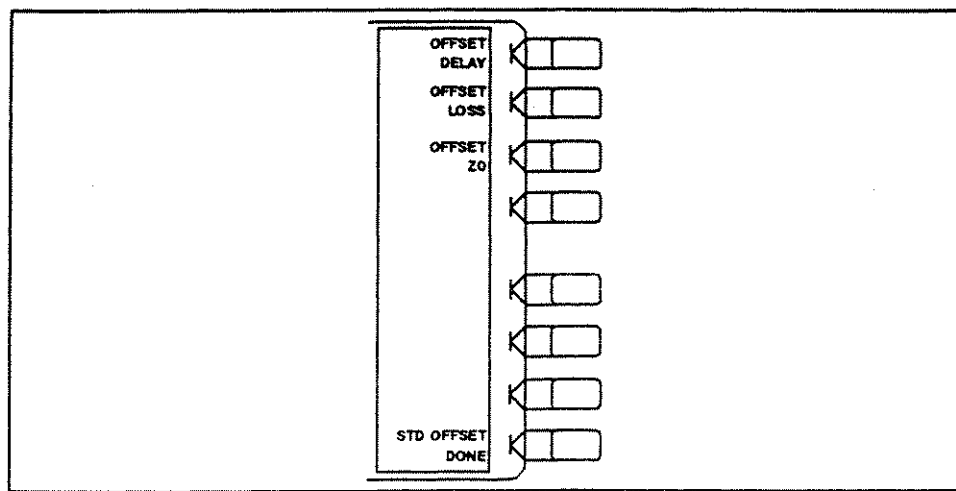

Figure 10-11. Specify Offset Menu

OFFSET DELAY (OFSD) specifies the one-way electrical delay from the measurement (reference) plane to the standard, in seconds (s). (In a transmission standard, offset delay is the delay from plane to plane.) Delay can be calculated from the precise physical length of the offset, the permittivity constant of the medium, and the speed of light.

OFFSET LOSS (OFSL) specifies energy loss, due to skin effect, along a one-way length of coaxial cable offset. The value of loss is entered as ohms/nanosecond (or Giga ohms/second) at 1 GHz.

OFFSET Z0 (OFSZ) specifies the characteristic impedance of the coaxial cable offset.

Note This is not the impedance of the standard itself.



Label Standard Menu

This menu labels (reference) individual standards during the menu-driven measurement calibration sequence. The labels are user-definable using a character set displayed on the display that includes letters, numbers, and some symbols, and they may be up to ten characters long. The analyzer will prompt you to connect standards using these labels, so they should be meaningful to you, and distinct for each standard.

By convention, when sexed connector standards are labeled male (m) or female (f), the designation refers to the test port connector sex, not the connector sex of the standard.

Standard labels are created in the same way as titles. See “**DISPLAY** Key” in Chapter 9, “Title Menu” in Chapter 9.

Specify Class Menus

Once a standard is specified, it must be assigned to a standard *class*. This is a group of from one to seven standards that is required to calibrate for a single error term. The standards within a single class are assigned to locations A through G as listed on the Standard Class Assignments Table (Table 10-3). A class often consists of a single standard, but may be composed of more than one standard.

The standard class assignments of predefined standard kits are shown in Appendix B.

Table 10-3. Standard Class Assignments Table

CLASS	A	B	C	D	E	F	G	STANDARD CLASS LABEL
S _{11A}								
S _{11B}								
S _{11C}								
Response								
Response & Isolation								

The number of standard classes required depends on the type of calibration being performed, and is identical to the number of error terms corrected. (Examples: A response cal requires only one class, and the standards for that class may include an OPEN, or SHORT, or THRU. A 1-port cal requires three classes.)

The number of standards that can be assigned to a given class may vary from none (class not used) to one (simplest class) to seven. When a certain class of standards is required during calibration, the analyzer will display the labels for all the standards in that class (except when the class consists of a single standard). This does not, however, mean that all standards in a class must be measured during calibration. Only a single standard per class is required. Note that it is often simpler to keep the number of standards per class to the bare minimum needed (often one) to avoid confusion during calibration.

Standards are assigned to a class simply by entering the standard's reference number (established while defining a standard) under a particular class.

Each class can be given a user-definable label as described under "Label Class Menu".

The class assignments table can be displayed on screen and printed using the COPY function. (See Chapter 13.)

SPECIFY: S11A (SPECS11A) enters the standard numbers for the first class required for a 3-term calibration. (For predefined cal kits, this is OPEN (for the 7 mm) or OPENS (for type-N).)

S11B (SPECS11B) enters the standard numbers for the second class required for a 3-term calibration. (For predefined cal kits, this is SHORT (for the 7 mm) or SHORTS (for the type-N) .)

S11C (SPECS11C) enters the standard numbers for the third class required for a 3-term calibration. (For predefined kits, this is the LOAD.)

MORE leads to the following softkeys.

RESPONSE (SPECRESP) enters the standard numbers for a response calibration. This calibration corrects for frequency response in either reflection or transmission measurements, depending on the parameter being measured when a calibration is performed. (For predefined kits, the standard is either the OPEN or SHORT for reflection measurements, or the THRU for transmission measurements.)

RESPONSE & ISOL'N (SPECRESI) enters the standard numbers for a response & isolation calibration. This calibration corrects for frequency response and directivity in reflection measurements, or frequency response and isolation in transmission measurements.

Label Class Menu

These define meaningful labels for the calibration classes. These then become softkey labels during a measurement calibration. Labels can be up to ten characters long.

Labels are created in the same way as display titles. See **DISPLAY** Key, "Title Menu" in Chapter 9.

Label Kit Menu

After a new calibration kit has been defined, be sure to specify a label for it. Choose a label that describes the connector type of the calibration devices. This label will then appear in the **CAL KIT** softkey label in the correction menu and the **MODIFY** label in the select cal kit menu. It will be saved with calibration data.

This menu is accessed with the **LABEL KIT** softkey in the modify cal kit menu, and is identical to the label class menu and the label standard menu described above. It allows definition of a label up to eight characters long.

Verify Performance

Once a measurement calibration has been generated with a user-defined calibration kit, its performance should be checked before making device measurements. To check the accuracy that can be obtained using the new calibration kit, a device with a well-defined frequency response should be measured. The verification device must not be one of the calibration standards: measurement of one of these standards is merely a measure of repeatability.

To achieve more complete verification of a particular measurement calibration, accurately known verification standards with a diverse magnitude and phase responses should be used. NIST traceable or HP standards are recommended to achieve verifiable measurement accuracy.

Note



The published specifications for the HP 87510A network analyzer system include accuracy enhancement with compatible calibration kits. Measurement calibrations made with user-defined or modified calibration kits are not subject to the HP 87510A specifications, although a procedure similar to the system verification procedure may be used.

Using Markers

MKR Key

The HP-IB programming command is shown in parenthesis following the key or softkey.

The **MKR** key displays a movable active marker (∇) on the screen and provides access to a series of menus to control one to eight display markers for each channel (a total of sixteen). Markers obtain numerical readings of measured values. They also provide capabilities for reducing measurement time by changing stimulus parameters, searching the trace for specific values, or statistically analyzing part or all of the trace.

Markers have a stimulus value (the x-axis value in Cartesian format) and a response value (the y-axis value in a Cartesian format). In a polar chart format, the second part of a complex data pair is also provided as an auxiliary response value. When a marker is turned ON and no other function is active, its stimulus value is displayed in the active entry area and can be controlled with the knob, the step keys, or the numeric keypad. The active marker can be moved to any point on the trace, and its response and stimulus values are displayed at the top right corner of the graticule for each displayed channel, in units appropriate to the display format. The displayed marker response values are valid even when the measured data is above or below the range displayed on the graticule. When the marker list is turned ON, the stimulus values and response values of all markers are listed on the graticule.

When the marker time mode is turned ON, the x-axis is changed to the time scale, where the start point of the x-axis is 0 seconds and the stop point indicates the sweep time and markers have a time instead of a stimulus value.

Marker values are normally continuous: that is, they are interpolated between measured points. Alternatively, they can be set to read only discrete measured points. The markers for the two channels normally have the same stimulus values, or they can be uncoupled so that each channel has independent markers, regardless of whether stimulus values are coupled or dual channel display is ON.

If both the data trace and the sub trace are displayed using LOGMAG & PHASE or LOGMAG & DELAY format, you can select which marker values apply to the data trace or the sub trace.

With the use of a reference marker, a delta marker mode is available that displays both the stimulus and response values of the active marker relative to the reference. Any of the eight markers or a fixed point can be designated as the delta reference marker. If the delta reference is one of the eight markers, its stimulus value can be controlled by the user and its response value is the value of the trace at that stimulus value. If the delta reference is a fixed marker, both its stimulus value and its response value can be set arbitrarily by the user anywhere in the display area (not necessarily on the trace).

Markers can search for the trace maximum, minimum, mean point, any other point, peak maximum, minimum or peak-to-peak value of all or part of the trace. The eight markers can be used together to search for specified bandwidth cutoff points and to calculate the bandwidth. Statistical analysis uses markers to provide a readout of the mean, standard deviation, and peak-to-peak values of all or part of the trace.

Basic marker operations are available in the menus accessed from the **(MKR)** key. The marker search and statistical functions, together with the capability for quickly changing stimulus parameters with markers, are provided in the menus accessed from the **(MKR FCTN)** key.

Note



The marker functions are not affected by waveform analysis command execution. For more information on the wave form analysis commands, see the *HP 87510A HP-IB Programming Manual*.

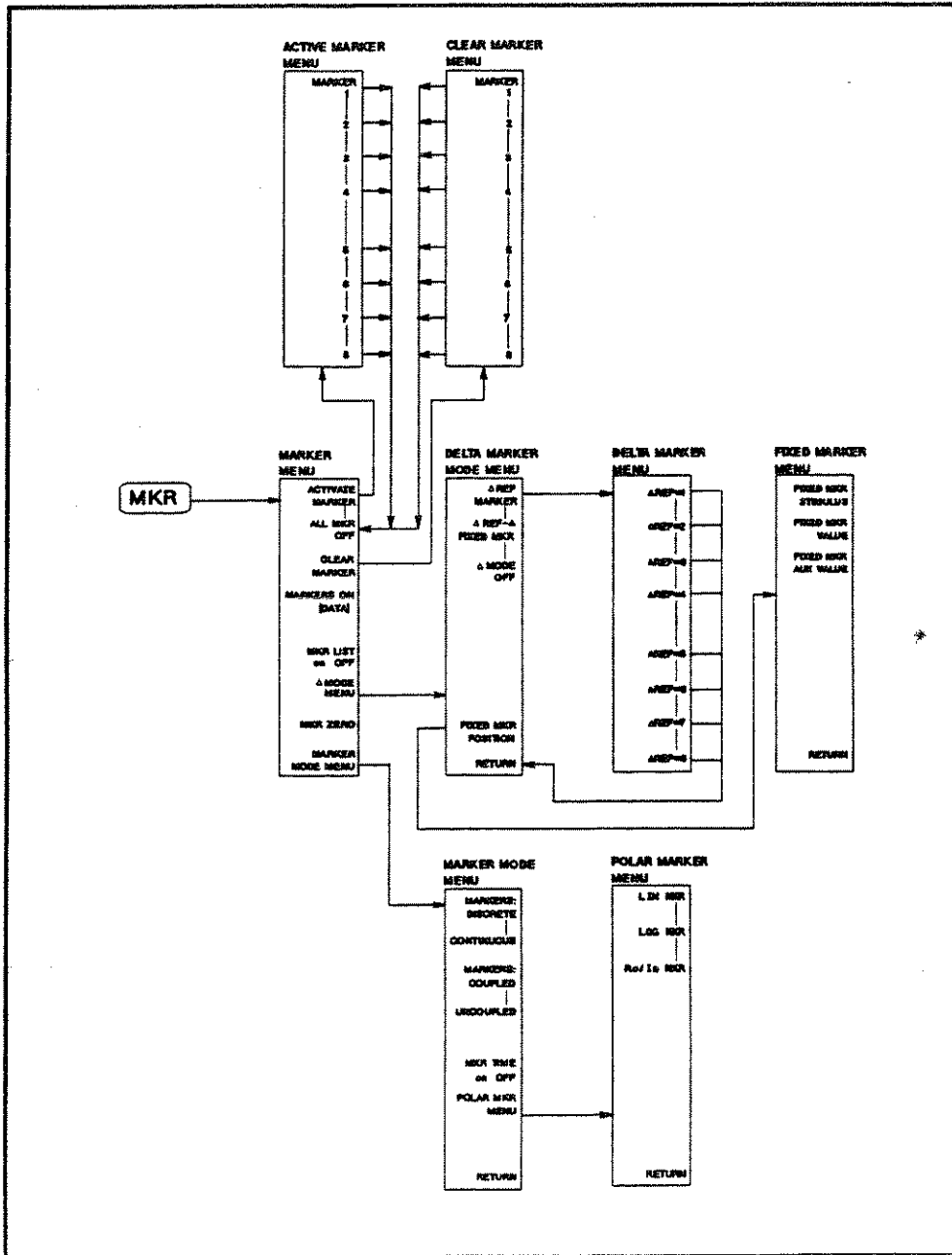

Figure 11-1. Menus Accessed from the **(MKR)** Key

The menus accessed from the **MKR** key (Figure 11-1) provide several basic marker operations. These include different marker modes for different display formats, and the delta marker mode that displays marker values relative to a specified value.

Marker Menu

The marker menu (Figure 11-2) goes to the activate marker menu or clear marker menu to turn the display markers ON or OFF, to assign a markers to a data trace or sub trace, to list marker values, or to gain access to the marker delta mode and other marker modes and formats.

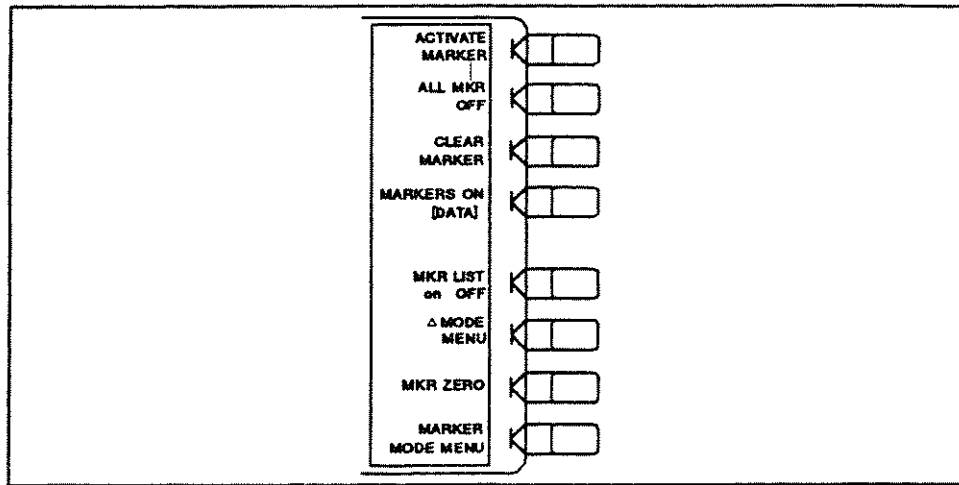

Figure 11-2. Marker Menu

ACTIVATE MARKER goes to the activate marker menu, from which the marker are activated.

ALL MKR OFF (MARKOFF) turns OFF all the markers and the delta reference marker, as well as the tracking and bandwidth functions that are accessed with the **MKR FCTN** key.

CLEAR MARKER goes to the clear marker menu, from which to turn OFF a marker.

MARKERS ON [DATA] (MARKODATA, MARKOMEMO) selects the data trace data or the sub trace to be applied for the marker values when the LOG MAG & PHASE or LOG MAG & DELAY format is selected.

MKR LIST on off (MARKLON, MARKLOFF) lists stimulus values and response values of all markers. In Δ mode, this lists all delta markers and fixed markers.

Δ MODE MENU goes to the delta marker menu, which reads the difference in values between the active marker and a reference marker.

MKR ZERO (MARKZERO) puts a fixed reference marker at the present active marker position, and sets the fixed marker stimulus and response values at that position equal to zero. All subsequent stimulus and response values of the active marker are then read out relative to the fixed marker. The fixed marker is shown on the display as a small triangle " Δ " (delta), smaller than the inactive marker triangles. The softkey label changes from **MKR ZERO** to **MKR ZERO Δ REF = Δ** and the notation " Δ REF= Δ " is displayed at the top right corner of the

graticule. The marker zero is canceled by turning the delta mode OFF from the delta marker menu or turning all the markers OFF with the **ALL MKR OFF** softkey.

MARKER MODE MENU provides access to the marker mode menu, where several marker modes can be selected including special markers for polar chart format.

Activate marker menu

This menu (Figure 11-3) turns the display markers ON and to designate the active marker.

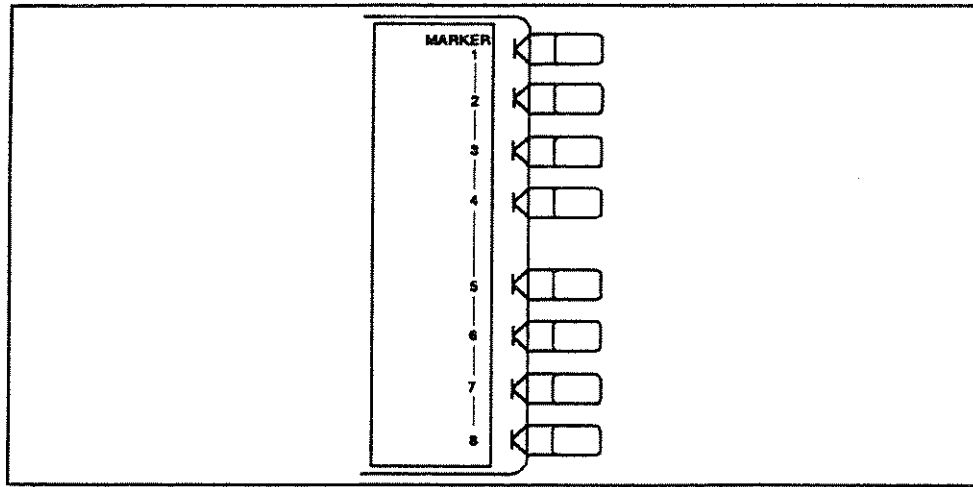

Figure 11-3. Activate Marker Menu

MARKER 1 (MARK1) turns on marker 1 and makes it the active marker. The active marker appears on the display as "▽". The active marker stimulus value is displayed in the active entry area, together with the marker number. If there is a marker turned ON, and no other function is active, the stimulus value of the active marker can be controlled with the knob, the step keys, or the numeric keypad. The marker response and stimulus values are displayed in the upper right-hand corner of the screen.

MARKER 2 (MARK2) turns ON marker 2 and makes it the active marker. If another marker is present, that marker becomes inactive and is represented on the display as "△".

MARKER 3 (MARK3) turns ON marker 3 and makes it the active marker.

MARKER 4 (MARK4) turns ON marker 4 and makes it the active marker.

MARKER 5 (MARK5) turns ON marker 5 and makes it the active marker.

MARKER 6 (MARK6) turns ON marker 6 and makes it the active marker.

MARKER 7 (MARK7) turns ON marker 7 and makes it the active marker.

MARKER 8 (MARK8) turns ON marker 8 and makes it the active marker.

Clear Marker Menu

This menu (Figure 11-4) turns the display markers OFF. If an activated marker is cleared, the marker of lowest number, if any, will be activated.

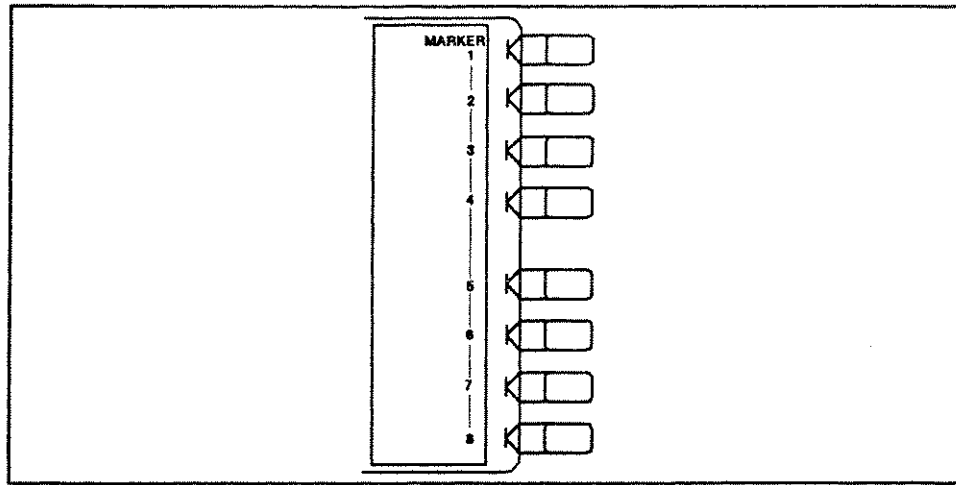

Figure 11-4. Clear Marker Menu

MARKER 1 (CLEM1) turns OFF marker 1.

MARKER 2 (CLEM2) turns OFF marker 2.

MARKER 3 (CLEM3) turns OFF marker 3.

MARKER 4 (CLEM4) turns OFF marker 4.

MARKER 5 (CLEM5) turns OFF marker 5.

MARKER 6 (CLEM6) turns OFF marker 6.

MARKER 7 (CLEM7) turns OFF marker 7.

MARKER 8 (CLEM8) turns OFF marker 8.

Delta Marker Mode Menu

The delta marker mode reads the difference in stimulus and response values between the active marker and a designated delta reference marker. Any of the eight markers or a fixed point can be designated as the reference marker. If the reference is one of the eight markers, its stimulus value can be controlled by the user and its response value is the value of the trace at that stimulus value. If the reference is a fixed marker, both its stimulus value and its response value can be set arbitrarily by the user anywhere in the display area. The delta reference is shown on the display as a small triangle Δ (delta), smaller than the inactive marker triangles (Δ). If one of the markers is the reference, the triangle appears next to the marker number on the trace.

The marker values displayed in this mode are the stimulus and response values of the active marker minus the reference marker. If the active marker is also designated as the reference marker, the marker values are zero.

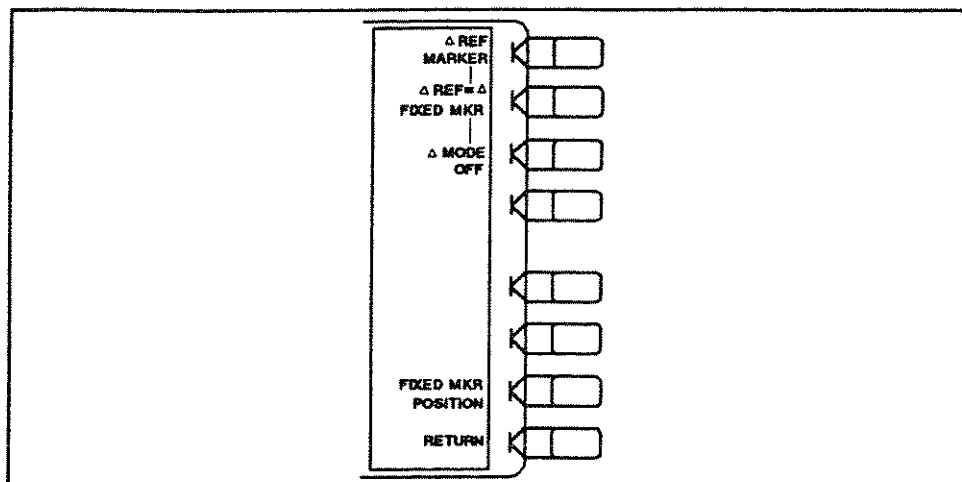

Figure 11-5. Delta Marker Mode Menu

Δ REF MARKER goes to the delta marker menu, which makes a marker the delta reference.

ΔREF=Δ FIXED MKR (DELRFIXM) sets a user-specified fixed reference marker. The stimulus and response values of the reference can be set arbitrarily, and can be anywhere in the display area. Unlike markers 1 to 8, the fixed marker need not be on the trace. The fixed marker is indicated by a small triangle Δ , and the active marker stimulus and response values are shown relative to this point. The notation " Δ REF= Δ " is displayed at the top right corner of the graticule.

Pressing this softkey turns ON the fixed marker. Its stimulus and response values can then be changed using the fixed marker menu, which is accessed with the **FIXED MKR POSITION** softkey described below. Alternatively, the fixed marker can be set to the current active marker position, using the **MKR ZERO** softkey in the marker menu.

Δ MODE OFF (DELO) turns OFF the delta marker mode, so that the values displayed for the active marker are absolute values.

FIXED MKR POSITION leads to the fixed marker menu, where the stimulus and response values for a fixed reference marker can be set arbitrarily.

RETURN goes back to the marker menu.

Delta Marker Menu

This menu (Figure 11-6) establishes a marker as a delta reference. The active marker stimulus and response values are shown relative to this delta reference. If marker 1 has been selected as the delta reference, **ΔREF=1** is underlined in this menu, and the marker menu is returned to the screen. In the activate marker menu under **ACTIVATE MARKER**, the first key is now labeled **MARKER Δ REF = 1**. The notation " Δ REF=1" appears at the top right corner of the graticule.

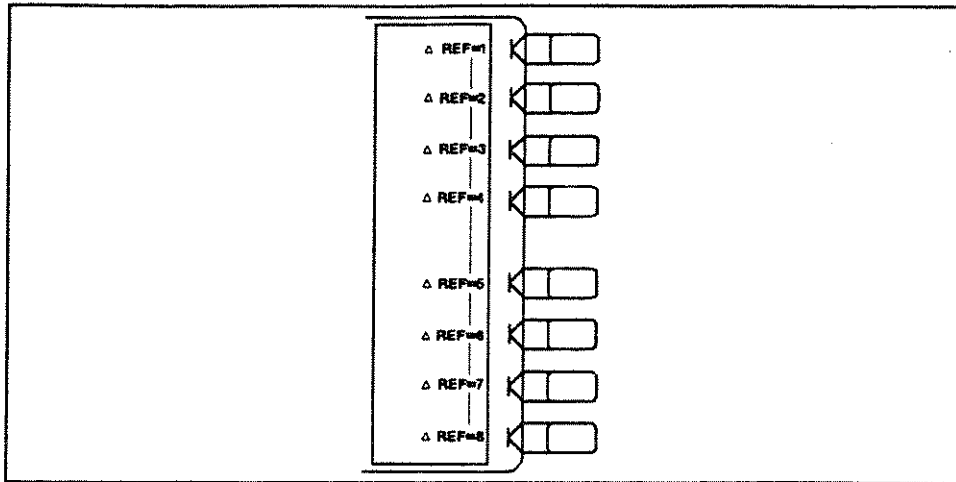

Figure 11-6. Delta Marker Menu

Δ REF = 1 (DELR1) makes marker 1 the delta reference.

Δ REF = 2 (DELR2) makes marker 2 the delta reference.

Δ REF = 3 (DELR3) makes marker 3 the delta reference.

Δ REF = 4 (DELR4) makes marker 4 the delta reference.

Δ REF = 5 (DELR5) makes marker 5 the delta reference.

Δ REF = 6 (DELR6) makes marker 6 the delta reference.

Δ REF = 7 (DELR7) makes marker 7 the delta reference.

Δ REF = 8 (DELR8) makes marker 8 the delta reference.

Fixed Marker Menu

This menu sets the position of a fixed reference marker, indicated on the display by a small triangle Δ . Both the stimulus value and the response value of the fixed marker can be set arbitrarily anywhere in the display area, and need not be on the trace. The units are determined by the display format and the marker type.

There are two ways to turn ON the fixed marker. One way is with the Δ REF = Δ FIXED MKR softkey in the delta marker mode menu. The other is with the MKR ZERO function in the marker menu, which puts a fixed reference marker at the present active marker position and makes the marker stimulus and response values at that position equal to zero.

The softkeys in this menu make the values of the fixed marker the active function. The marker readings in the top right corner of the graticule are the stimulus and response values of the active marker minus the fixed reference marker. Also displayed in the top right corner is the notation " Δ REF= Δ ".

The stimulus value, response value, and auxiliary response value (the second part of a complex data pair) can be individually examined and changed. This allows active marker readings that are relative in amplitude yet absolute in frequency, or any combination of relative/absolute

readouts. Following a **MKR ZERO** operation, this menu can reset any of the fixed marker values to absolute zero for absolute readings of the subsequent active marker values.

If the format is changed while a fixed marker is ON, the fixed marker values become invalid. For example, if the value offset is set to 10 dB with a log magnitude format, and the format is then changed to phase, the value offset becomes 10 degrees. However, in polar chart format, the specified values remain consistent between different marker types for those formats.

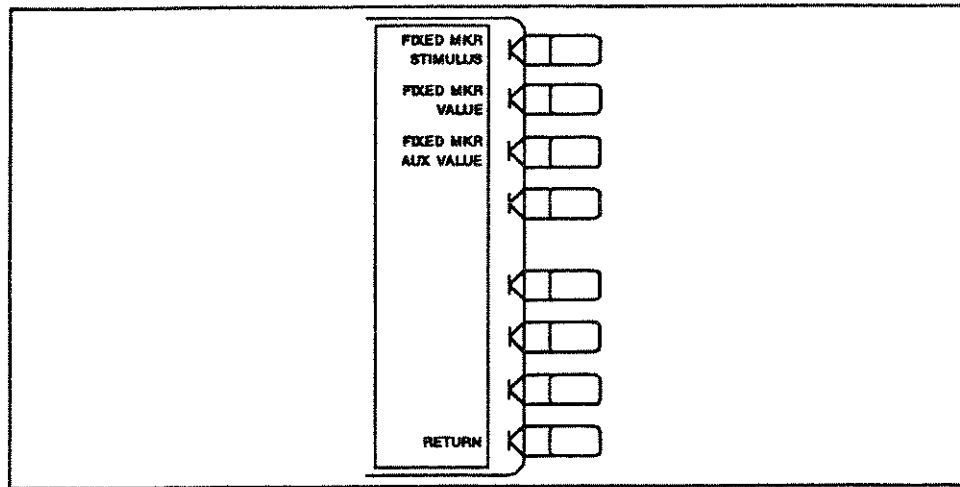

Figure 11-7. Fixed Marker Menu

FIXED MKR STIMULUS (MARKFSTI) changes the stimulus value of the fixed marker. Fixed marker stimulus values can be different for the two channels if the channel markers are uncoupled using the marker mode menu.

Absolute active marker stimulus values can be read, if the stimulus value is set to zero.

FIXED MKR VALUE (MARKFVAL) changes the response value of the fixed marker. In a Cartesian format this is the y-axis value. In a polar chart format with a magnitude/phase marker or a real/imaginary marker, this applies to the first part (real part) of the complex data pair. Fixed marker response values are always uncoupled in the two channels.

Absolute active marker response values can be read, if the response value is set to zero.

FIXED MKR AUX VALUE (MARKFAUV) is used only with a polar format. It changes the auxiliary response value of the fixed marker. This is the second part (imaginary part) of a complex data pair, and applies to a magnitude/phase marker or a real/imaginary marker. Fixed marker auxiliary response values are always uncoupled in the two channels.

Absolute active marker auxiliary response values can be read, if the auxiliary value is set to zero.

RETURN goes back to the delta marker mode menu.

Marker Mode Menu

This menu provides different marker modes and makes available an additional menu of special markers for use in the polar format.

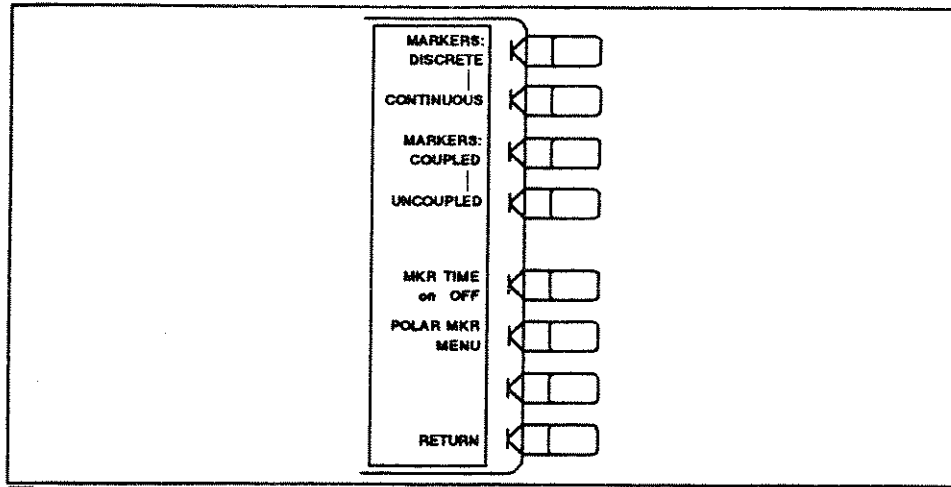

Figure 11-8. Marker Mode Menu

MARKERS: DISCRETE (MARKDISC) places markers only on measured trace points determined by the stimulus settings.

CONTINUOUS (MARKCONT) interpolates between measured points to allow the markers to be placed at any point on the trace. Displayed marker values are also interpolated. This is the default marker mode.

MARKERS: COUPLED (MARKCOUP) couples the marker stimulus values for the two display channels. Even if the stimulus is uncoupled and two sets of stimulus values are shown, the markers track the same stimulus values on each channel as long as they are within the displayed stimulus range.

UNCOUPLED (MARKUNCO) allows the marker stimulus values to be controlled independently on each channel.

MKR TIME on OFF (MARKTIMEON, MARKTIMEOFF) sets the x-axis units to time, where the start point is zero and the stop point is the value of the sweep time. A marker indicates the time passed after the sweep has started. This function is useful for testing a DUT's time transition characteristics at a certain fixed frequency by setting span to zero.

POLAR MKR MENU leads to the polar marker menu.

RETURN goes back to the marker menu.

Polar Marker Menu

This menu is used only with the polar display format, selectable using the **FORMAT** key. In the polar format, the magnitude at the center of the circle is zero and the outer circle is the full scale value set in the scale reference menu. Phase is measured as the angle counterclockwise from 0° at the positive x-axis. The analyzer automatically calculates different mathematical forms of the marker magnitude and phase values, selected using the softkeys in this menu. Marker frequency is displayed in addition to other values regardless of the marker type selected.

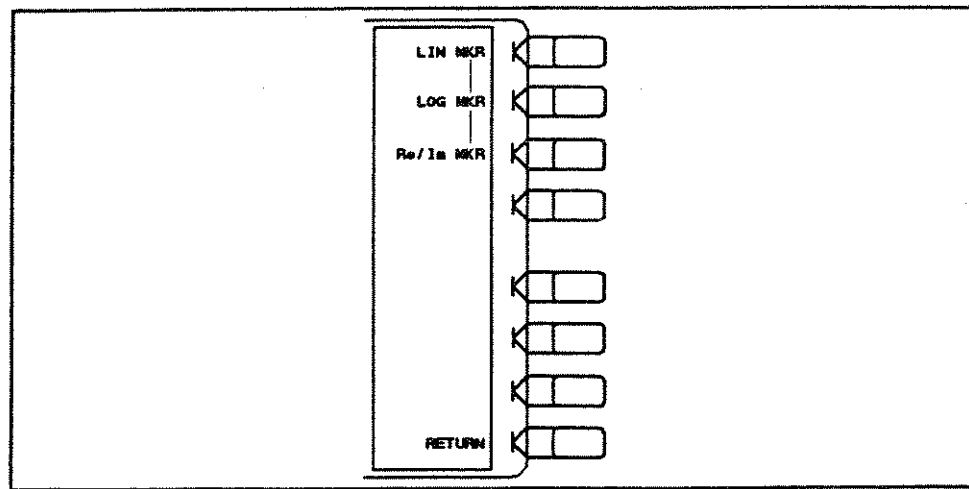

Figure 11-9. Polar Marker Menu

LIN MKR (POLMLIN) displays a readout of the linear magnitude and the phase of the active marker. This is the preset marker type for a polar display. Magnitude values are read in engineering units and phase in degrees.

LOG MKR (POLMLOG) displays the logarithmic magnitude and the phase of the active marker. Magnitude values are expressed in dB and phase in degrees. This is useful as a fast method of obtaining a reading of the log magnitude value without changing to the log magnitude format.

Re/Im MKR (POLMRI) displays the values of the active marker as a real and imaginary pair. The complex data is separated into its real part and its imaginary part. The first marker value given is the real part ($= M \cos \theta$), and the second value is the imaginary part ($= M \sin \theta$), where M = magnitude.

RETURN goes back to the marker mode menu.

MKR FCTN Key

The HP-IB programming command is shown in parenthesis following the key or softkey.

The MKR FCTN (KEY 17) key activates a marker if one is not already active, and provides access to additional marker functions. These can quickly change the measurement parameters, to search the trace for specified information, and to analyze the trace statistically.

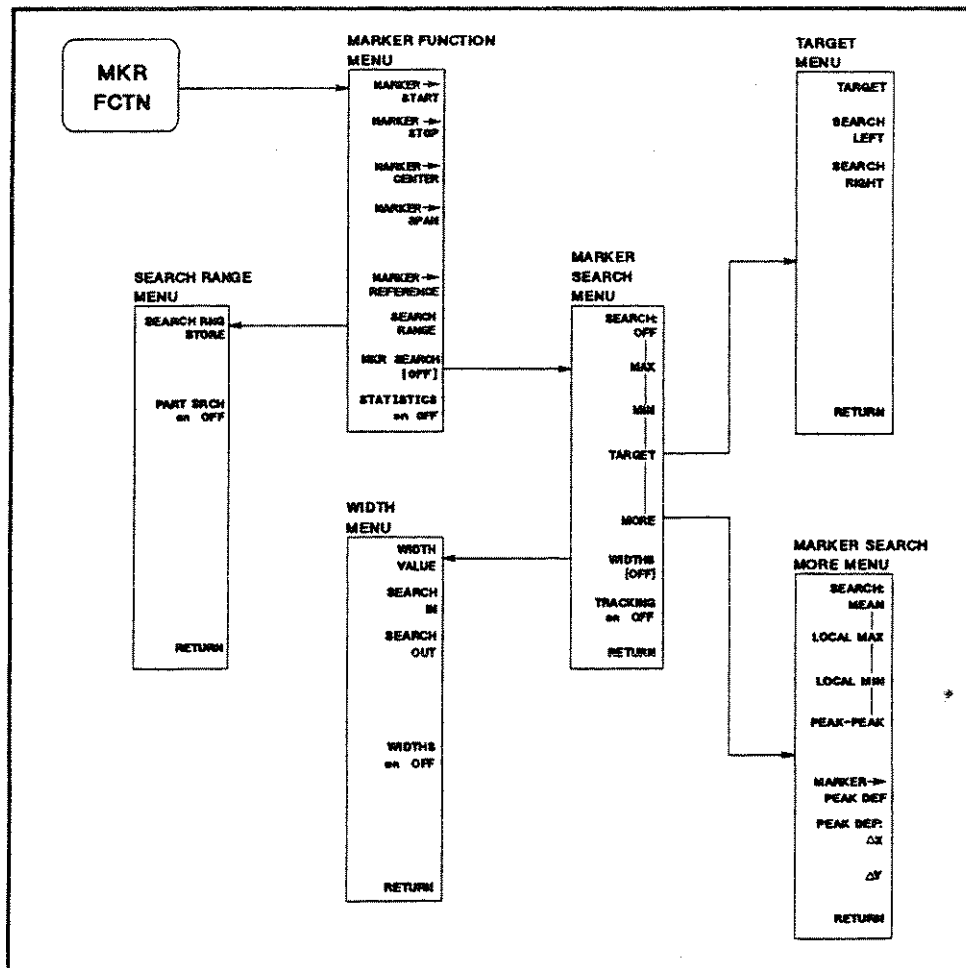

Figure 11-10. Menus Accessed from the MKR FCTN Key

Marker Function Menu

This menu provides softkeys that use markers to quickly modify certain measurement parameters without going through the usual key sequence. In addition, it provides access to five additional menus used for searching the trace, for storing the search range, and for statistical analysis.

The MARKER → functions change certain stimulus and response parameters to make them equal to the current active marker value. Use the knob or the numeric keypad to move the marker to the desired position on the trace, and press the appropriate softkey to set the specified parameter to that trace value. When the values have been changed, the marker can again be moved within the range of the new parameters.